

DATASHEET

TPM2860 RF Schottky Detection Diode

Description

- DNmicron's TPM2860 series have good RF application performance
- Used as DC bias detector diode
- The series of detection diodes could be packaged in a variety of formats, we assure that when two or more diodes are mounted into a single surface mount package, they are taken from adjacent sites on the wafer, assuring the highest possible degree of match

Features

- Multi packages SOD-523, SOT-23, SOT-143
- High detection sensitivity
- Tape and Reel Options Available
- Pb-free (RoHS compliant) package
- High matching of dual diode in package
- Better thermal conductivity for high power dissipation



ESD WARNING:

Handling Precautions Should Be Taken To Avoid Static Discharge.

Part Number and Configuration

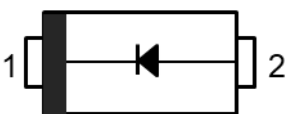
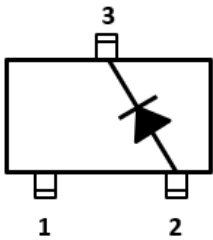
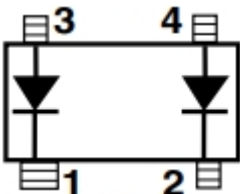
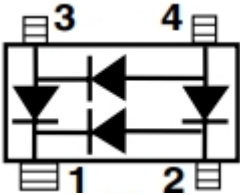
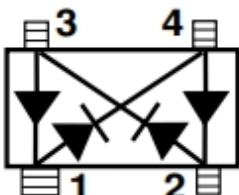
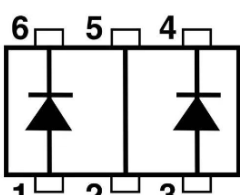
TPM2860C -01 SOD-523	TPM2860C -02 SOT-23	TPM2860C -05 SOT-143
		
TPM2860C -08 SOT-143	TPM2860C -09 SOT-143	TPM2860E -06 SOT-363
		

Direct Current Specifications at Tc=+25^o

Parameter	Symbol	Condition	min.	typ.	max.
Breakdown Voltage	V _{BD}	I _R = -10 μ A	5 V	10 V	-
Reverse Leakage Current	I _R	V _R = -3 V	-	80 nA	200 nA
Cut-in Voltage	V _F	I _F = 1 mA	-	358 mV	-
Forward Voltage Drop	V _{10mA}	I _F = 10 mA	-	0.9 V	-
Capacitance	C _T	V _R = 0 V, f = 1 MHz	-	0.18 pF	0.23 pF

Radio Frequency Electrical Specifications at Tc =+25^o

Parameter	Symbol	Condition (f=7.5 GHz)	typ.
Voltage-sensitivity	g	Input power= -30 dBm, R _L = 100 K Ω , I _b = 3 μ A	32 mV/ μ W
Video Resistance	R _V	I _b = 5 μ A	6.5 k Ω
Minimum Tangent Signal Sensitivity	TSS	I _F = 5 mA, BW = 2 MHz, Video NF = 1.5 dB	-55 dBm

Typical Performance Characteristics

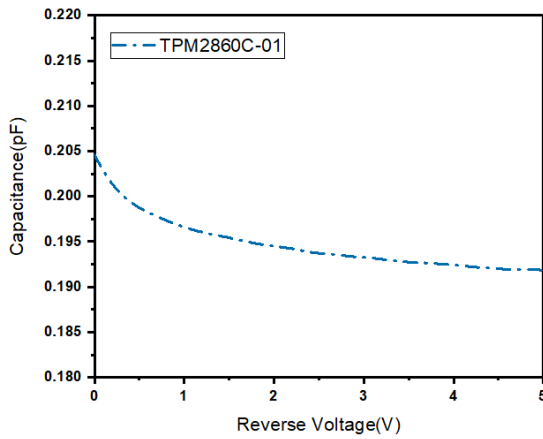
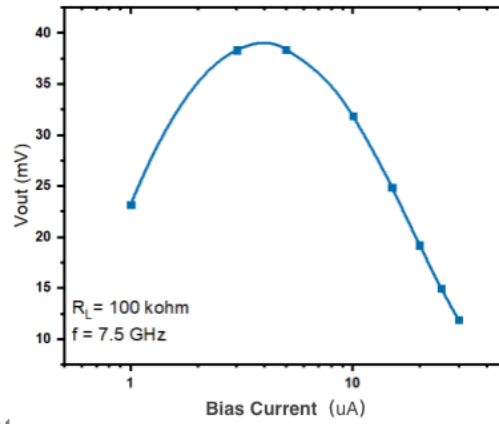
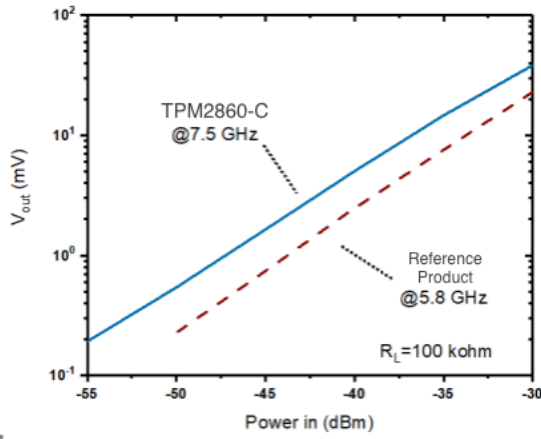
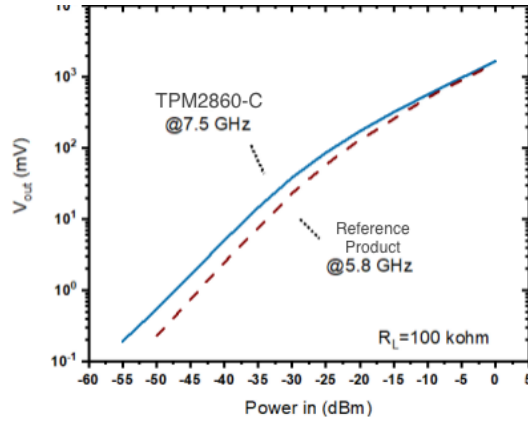
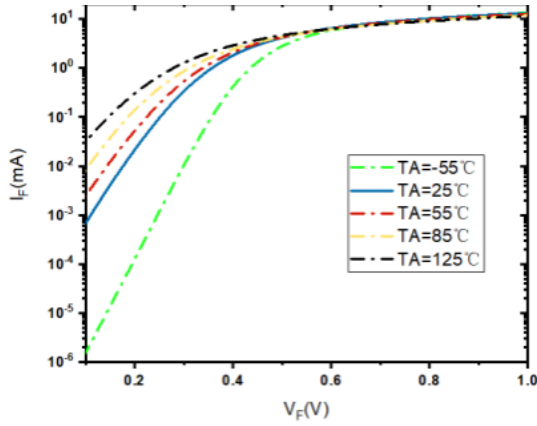

Typical Scattering Parameter S11 (No DC Bias, Power In = -30 dBm, Tc = +25 °C)

Freq GHz	0.7	0.8	0.9	1	1.1	1.2	1.3	1.4
MAG	0.992	0.998	0.998	0.997	0.996	0.998	0.997	0.998
PHASE	-14.5	-19.0	-21.8	-24.1	-25.6	-27.0	-29.8	-33.6
Freq GHz	1.5	1.6	1.7	1.8	1.9	2	2.1	2.2
MAG	0.996	0.994	0.994	0.999	0.997	0.994	0.998	0.995
PHASE	-34.2	-37.4	-39.1	-40.8	-43.4	-45.9	-49.6	-49.2
Freq GHz	2.3	2.4	2.5	2.6	2.7	2.8	2.9	3
MAG	0.999	0.998	0.996	0.993	0.999	0.998	0.992	0.999
PHASE	-54.4	-57.4	-58.0	-60.4	-64.6	-66.4	-70.1	-71.7
Freq GHz	3.1	3.2	3.3	3.4	3.5	3.6	3.7	
MAG	0.996	0.996	0.999	0.998	0.998	0.999	0.993	
PHASE	-74.0	-79.6	-80.9	-83.1	-86.6	-90.9	-93.5	

Package Dimension Drawing
SOT-23

Symbol	Dimensions (mm)	
	Min	Max
A1	0.04	0.10
A2	1.00	1.20
D	2.82	3.02
E	2.60	3.00
E1	1.50	1.70
e	0.95BSC	
L1	0.60REF	

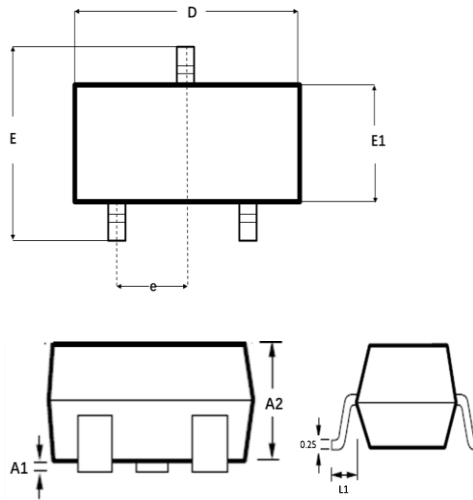

SOD-523

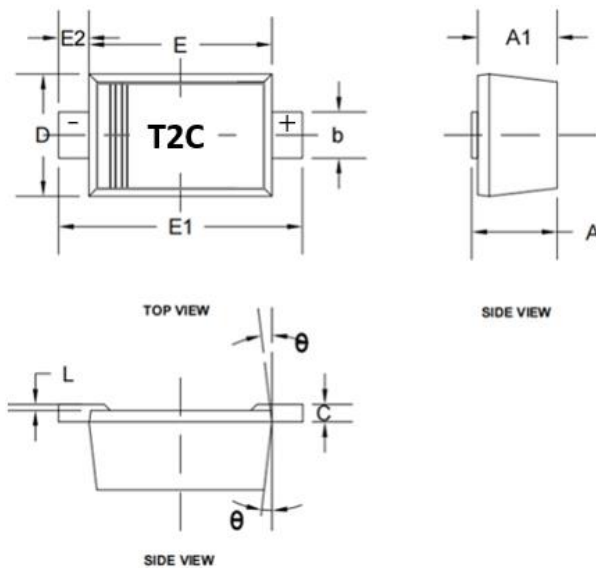
Symbol	Dimensions (mm)		
	Min	TYP	Max
A	0.460	0.560	0.660
A1	0.450	0.550	0.650
b	0.250	0.300	0.350
c	0.080	0.115	0.150
D	0.750	0.800	0.850
E	1.100	1.200	1.300
E1	1.500	1.600	1.700
E2	0.200REF		
L	0.010	0.040	0.070

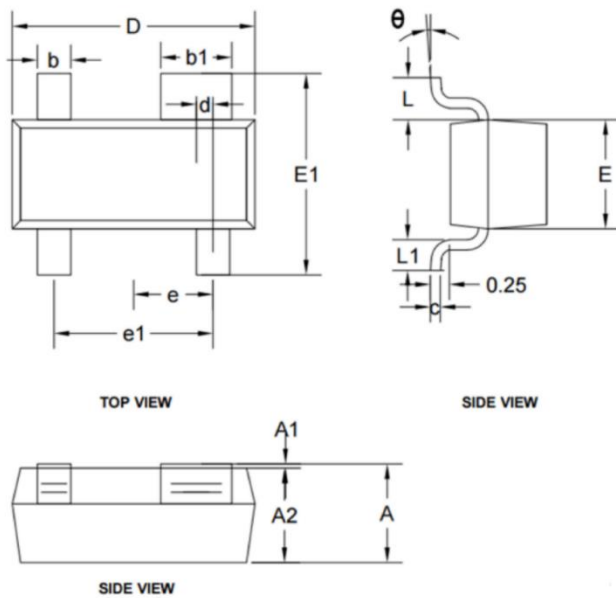

SOT-143

Symbol	Dimensions (mm)		
	Min	TYP	Max
A	0.950	1.125	1.300
A1	0.000	0.050	0.100
A2	0.900	1.050	1.200
b	0.300	0.400	0.500
b1	0.750	0.850	0.950
c	0.080	0.115	0.150
D	2.800	2.900	3.000
d	0.200TYP		
E	1.200	1.300	1.400
E1	2.250	2.400	2.550
e	0.950TYP		
e1	1.800	1.900	2.000
L	0.550TYP		
L1	0.300	0.400	0.500
θ	0°	4°	8°



SOT-363

Symbol	Dimensions (mm)
--------	-----------------

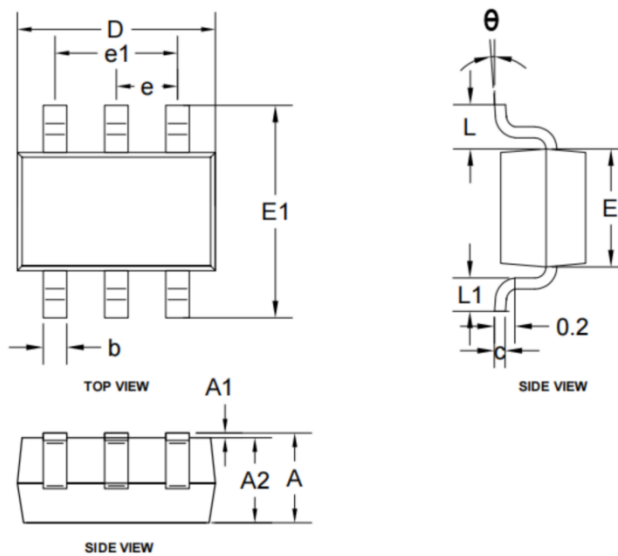

Disclaimer

General Information

The information in this datasheet is provided for reference only and is subject to change without notice. While efforts have been made to ensure accuracy, DNMICRON, INC. makes no warranties regarding the completeness or correctness of the data. Users are advised to verify product suitability for their specific applications.

Application Notes

The device's electrical characteristics and performance data are general guidelines. Any application-specific configurations must be independently verified. DNMICRON, INC. is not responsible for misuse or damage resulting from improper use or incorrect application.

No Liability

DNMICRON, INC. is not liable for any direct, indirect, or consequential damages arising from the use of the product. The user assumes all risks associated with the device's use in their systems.

Warranty

Products are covered by the standard warranty policy. For warranty terms and conditions, refer to the DNMICRON, INC. Warranty Policy.

Compliance

Users are responsible for ensuring that their use of the product complies with all applicable laws and regulations. The product may comply with RoHS and REACH standards.

Changes

DNMICRON, INC. reserves the right to update or discontinue the datasheet or product without notice. Updated information will be provided via the official website.

Contact Information

For further information, please contact:

Website: www.dnmicron.com

Email: sales@dnmicron.com