



<b>SPECIFICATION SHEET NO.</b>	S0219 – SS510C0000S100	
<b>ORIGINAL MFG/PART NO.</b>	MDD Diodes/SS510C	
<b>NEXTGEN PART CODE</b>	SS510C0000S100	Indicate This Code For <a href="#">RFQ/Order</a>
<b>DATE</b>	Feb. 19, 2025	
<b>REVISION</b>	A2	Updated With Most Recent Data
<b>DESCRIPTION AND MAIN PARAMETRICS</b>	<p>SMD Schottky Barrier Rectifier 2 Pads, Case DO-214AB/SMC, SS5 Series,            Average Forward Rectified Current 5.0A Max.            RMS Voltage 70V Max.            Repetitive Peak Reverse Voltage 100V Max.            Operating Junction Temperature Range TJ: -55°C ~+150°C            Package in Tape/Reel, 3000pcs/Reel            RoHS III/REACH Compliant and Halogen Free (HF)</p>	
<b>CUSTOMER</b>		
<b>CUSTOMER PART NUMBER</b>		
<b>CROSS REF. PART NUMBER</b>		
<b>MEMO</b>		

<b>VENDOR APPROVE</b>		
Issued/Checked/Approved		 
Effective Date: Feb. 19, 2025		

<b>CUSTOMER APPROVE</b>	
Date:	

## MAIN FEATURE

- The Plastic Package Carries Underwriters Laboratory Flammability Classification 94V-0
- Low Power Loss and High Efficiency
- Metal Silicon Junction and Majority Carrier Conduction
- Built-in Strain Relief and Ideal For Automated Placement
- High Forward Surge Current Capability
- High Temperature Soldering Guaranteed: 250° C/10 Seconds At Terminals
- Surface Mount Package Ideally Suited for Automatic Insertion
- REACH/RoHS III Complaint and Halogen Free
- Cross Main Competitor Parts in Market



*Image shown is a representation only. Exact specifications should be obtained from the product dimension.*



## APPLICATION

- For SMD Application

## ELECTRICAL CHARACTERISTICS

- See Page 5 ~ Page 6
- All Products Parameters are Subject To NextGen Components' Final Confirmation.

## HOW TO ORDER

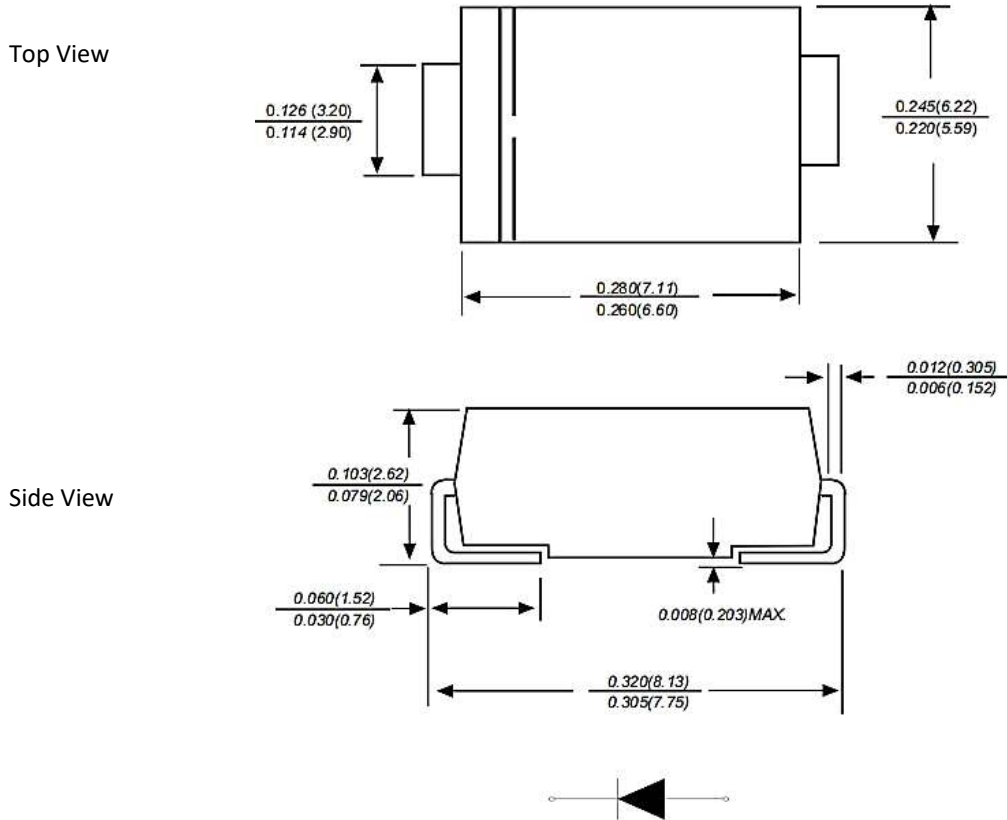
- Please Follow Up Part Code Guide And Indicate NextGen Part Code SS510C0000S100 For RFQ and Order.

## PART CODE GUIDE

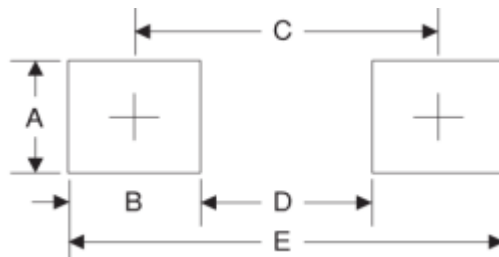
**RFQ**  
[Request For Quotation](#)

CODE	NAME	KEY SPECIFICATION OPTION
SS5	Product Series Code	SMD Schottky Barrier Rectifier, Forward Current 5.0A
10	Repetitive Peak Reverse Voltage Code	2: 20V Max. ; 3: 30V Max. ; 4: 40V Max.; 5: 50V Max.; 6: 60V Max.; 8: 80V Max.; 10: 100V Max.; 150: 150V Max.; 200: 200V Max
C0	Case Code	A0: Case DO-214AC/SMA; B0: Case DO-214AA/SMB; BF: Case SMBF; C0: Case SMC/DO-214AB ; F0: Case SMAF; W0: Case SMF/SOD-123FL
000S	Internal Control Code	000S: Letter A~Z, a-z or Digits (0-9)
100	DC Blocking Voltage Code	020: 20V Max. ; 030: 30V Max. ; 040: 40V Max.; 050: 50V Max.; 060: 60V Max.; 080: 80V Max.; 100: 100V Max.; 150: 150V Max.; 200: 200V Max
XX	Special/Custom Parameters	Blank: N/A; XX: Letter A~Z, a~z or digits (0~9) for Special/Custom Parameters

**DIMENSION** - Unit: Inch (mm), Case DO-214AB/SMC Outline



**Recommend Pad Layout**



SYMBOL	A	B	C	D	E
Unit (inch)	0.170	0.160	0.311	0.150	0.472
Unit (mm)	4.30	4.10	7.90	3.80	12.0

**MECHANICAL DATA**

CASE	TERMINALS	POLARITY	MOUNTING POSITION	WEIGHT PER PIECE
JEDEC DO-214AB/SMC Molded Plastic Body	Solder plated, Solderable per MIL-STD-750, Method 2026	Color band denotes cathode end Mounting	Any	0.0077 Ounce, 0.22 Grams

**MAX. RATINGS & ELECTRICAL CHARACTERISTICS**

- Ratings at 25 °C ambient temperature unless otherwise specified.
- Single phase half-wave 60Hz, resistive or inductive load, for capacitive load current derate by 20%.

PARAMETER		SYMBOLS	VALUE	UNITS
Maximum Average Forward Rectified Current		I (AV)	5.0	A
Peak Forward Surge Current 8.3ms	@V <sub>RMM</sub> 20V to 60V	I <sub>FSM</sub>	175	A
Single Half Sine-wave Superimposed On Rated Load (JEDEC Method)	@V <sub>RMM</sub> 80V to 200V		150	
Typical Thermal Resistance (Note 2)		R <sub>θJA</sub>	35	°C/W
Operating Junction Temperature Range	@V <sub>RMM</sub> 20V to 50V	T <sub>J</sub>	-55 to +125	°C
	@V <sub>RMM</sub> 60V to 200V		-55 to +150	
Storage Temperature Range		T <sub>STG</sub>	-55 to +150	°C

Note:

1. Measured at 1MHz And Applied Reverse Voltage Of 4.0V D.C
2. P.C.B. Mounted With 0.2"x0.2"(5.0 x 5.0 mm) Copper Pad Areas

**MAX. RATINGS & ELECTRICAL CHARACTERISTICS** - FOR DIFFERENT PART CODE

- Ratings At 25 °C Ambient Temperature Unless Otherwise Specified.
- Single Phase Half-wave 60Hz, resistive Or Inductive Load, For Capacitive Load Current Derate By 20%.

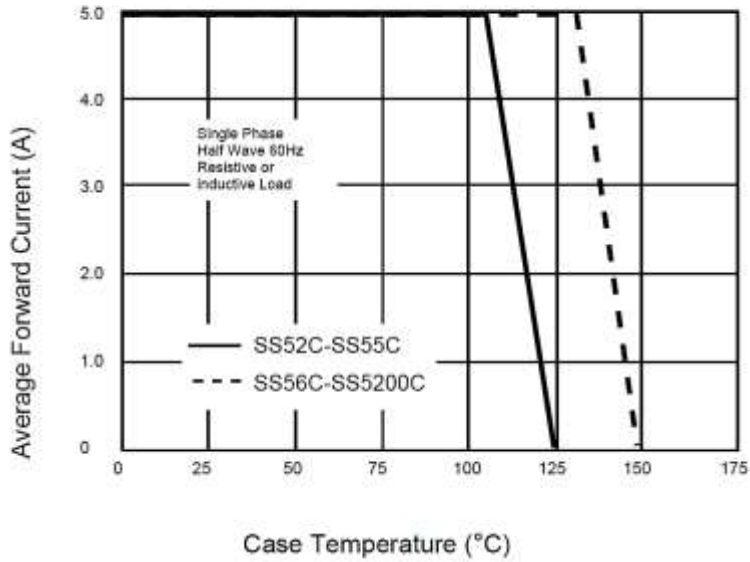
PART CODE	Max. Repetitive Peak Reverse Voltage	Max. RMS Voltage	Max. DC Blocking Voltage	Max. Inst. Forward Voltage @ 5.0A	Maximum DC Reverse Current At Rated DC Blocking Voltage		Typical Junction Cap. (Note 1)	Marking List				
					@ 25 °C	@ 100 °C						
					V <sub>RRM</sub>	V <sub>RMS</sub>			V <sub>DC</sub>	V <sub>F</sub>	I <sub>R</sub>	C <sub>J</sub>
					V	V			V	V	mA	pF
SS52C0000S020	20	14	20	0.55	1.0	50	600	SS52C				
SS53C0000S030	30	21	30	0.55	1.0	50	600	SS53C				
SS54C0000S040	40	28	40	0.55	1.0	50	600	SS54C				
SS55C0000S050	50	35	50	0.70	1.0	50	400	SS55C				
SS56C0000S060	60	42	60	0.70	1.0	50	400	SS56C				
SS58C0000S080	80	56	80	0.85	1.0	50	400	SS58C				
<a href="#">SS510C0000S100</a>	100	70	100	0.85	1.0	50	400	SS510C				
SS5150C000S150	150	105	150	0.85	1.0	50	400	SS5150C				
SS5200C000S200	200	140	200	0.85	1.0	50	400	SS5200C				

Note:

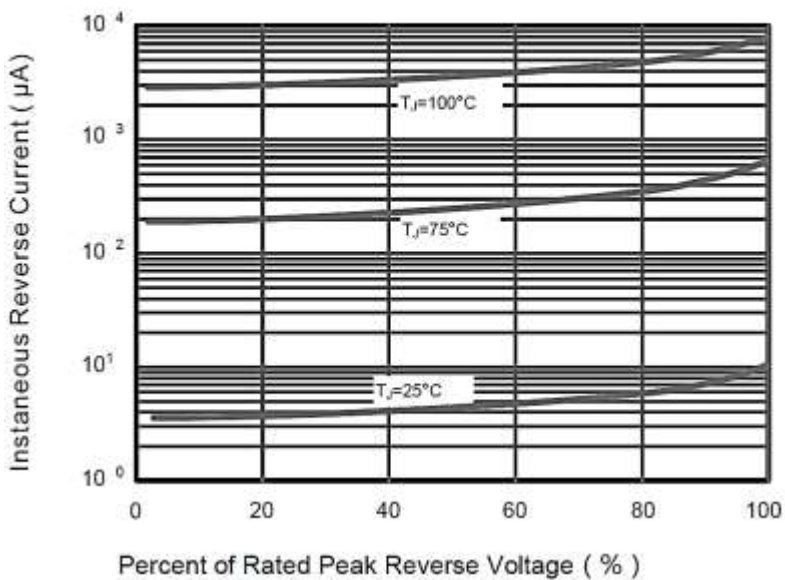
1. Measured at 1MHz And Applied Reverse Voltage Of 4.0V D.C
2. P.C.B. mounted with 0.20"x0.20" (5.0 x 5.0 mm) Copper Pad Areas

**RATINGS & CHARACTERISTIC CURVES** - For Reference Only

**Fig.1 Forward Current Derating Curve**

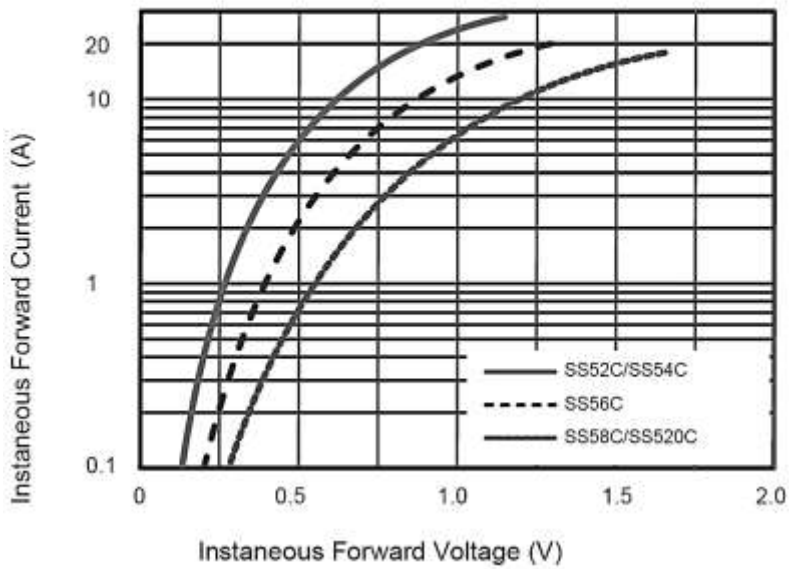


**Fig.2 Typical Reverse Characteristics**

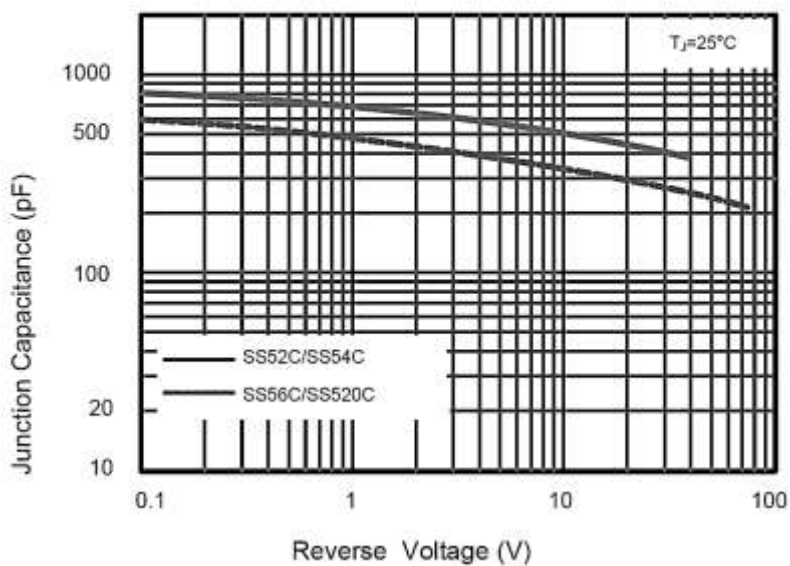


**RATINGS & CHARACTERISTIC CURVES** - For Reference Only

**Fig.3 Typical Forward Characteristic**

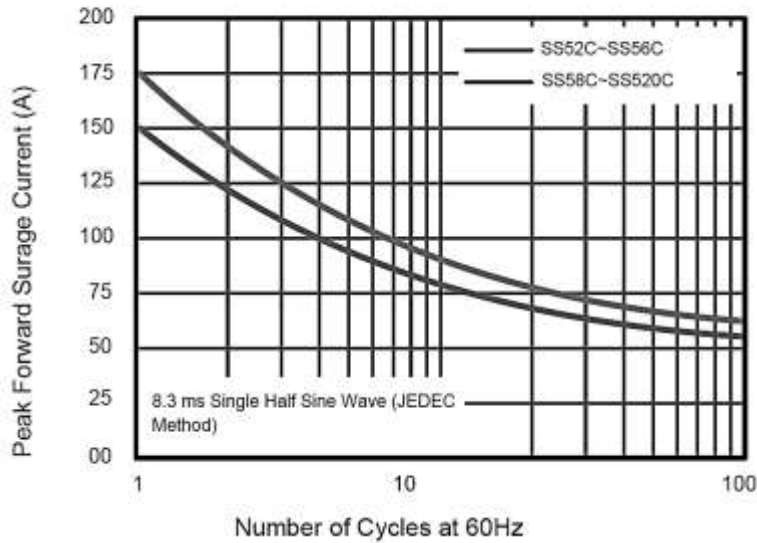


**Fig.4 Typical Junction Capacitance**

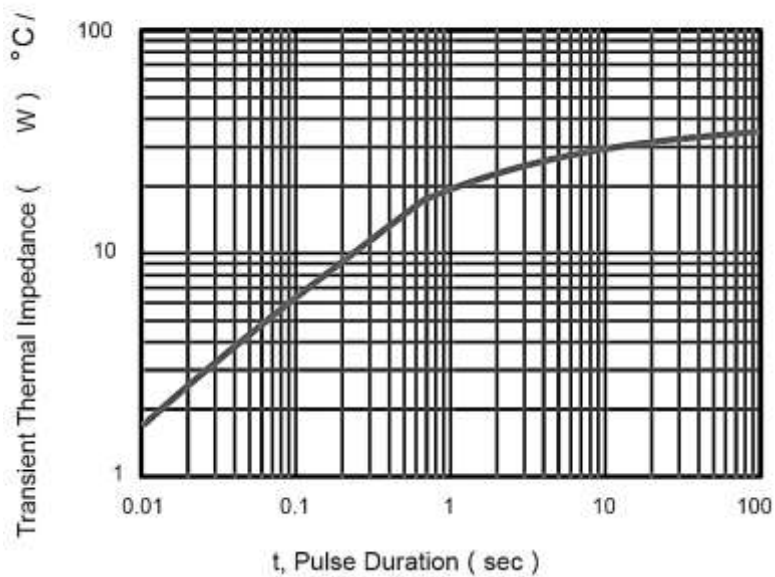


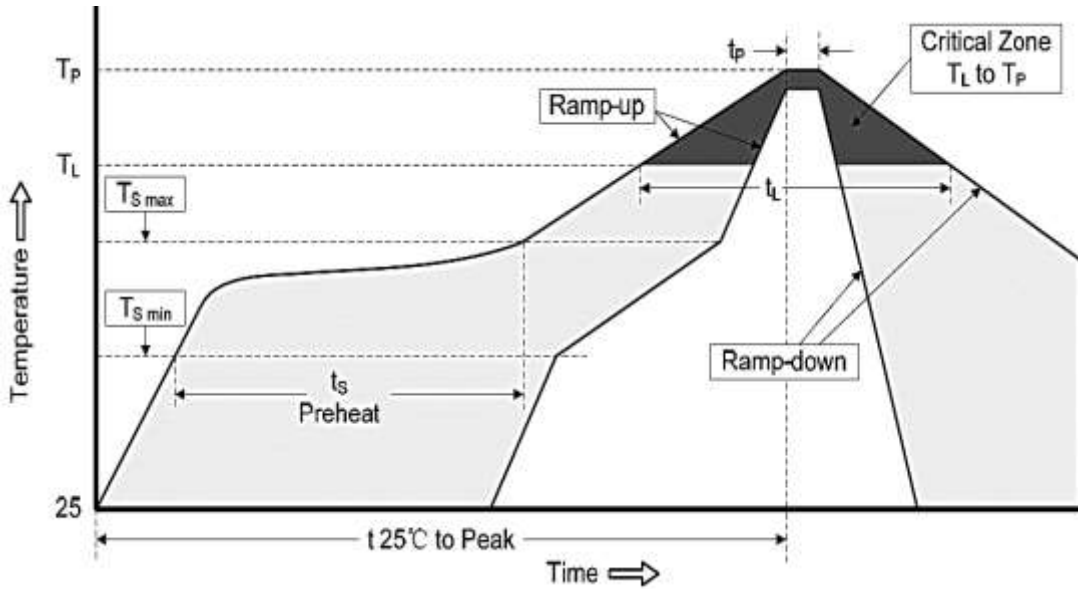
**RATINGS & CHARACTERISTIC CURVES** - For Reference Only

**Fig.5 Maximum Non-Repetitive Peak Forward Surge Current**



**Fig.6- Typical Transient Thermal Impedance**

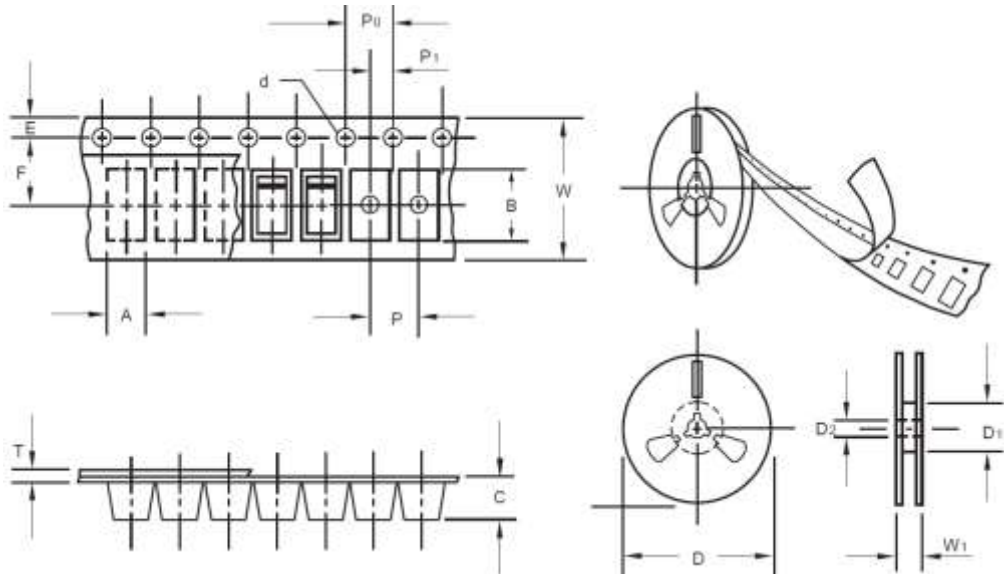


**SUGGESTED REFLOW PROFILE - For Reference Only**


PROFILE FEATURE		PB-FREE ASSEMBLY
Average Ramp-up Rate ( $T_S \text{ Max}$ to $T_P$ )		3°C/second Max
Preheat	Temperature Min ( $T_S \text{ Min.}$ )	150°C
	Temperature Max ( $T_S \text{ Max.}$ )	200°C
	Time ( $t_s \text{ Min.}$ to $t_s \text{ Max.}$ )	60 ~ 180 seconds
Time maintained above	Temperature ( $T_L$ )	217°C
	Time ( $t_l$ )	60 ~ 150 seconds
Peak/Classification Temperature ( $T_P$ )		260 °C
Time within 5°C of actual Peak Temperature ( $t_p$ )		20 ~ 40 seconds
Ramp-down rate		6 °C /Second Max.
Time 25 °C to Peak Temperature		8 minutes Max.
Suggest reflow times		3 Times Max.

**TAPE AND REEL (Unit: mm)**

- All Devices are packed in accordance with EIA standard RS-481-A and specifications.



ITEM	SYMBOL	TOLERANCE	SMC/DO-214AB
Carrier width	A	0.1	6.15
Carrier Length	B	0.1	8.41
Carrier Depth	C	0.1	2.42
Sprocket hole	d	0.05	1.50
13" Reel outside diameter	D	2.0	330.00
13" Reel inner diameter	D1	Min.	50.00
Feed hole diameter	D2	0.5	13.00
Sprocket hole position	E	0.1	1.75
Punch hole position	F	0.1	7.50
Punch hole pitch	P	0.1	8.00
Sprocket hole pitch	P0	0.1	4.00
Embossment center	P1	0.1	2.00
Overall tape thickness	T	0.1	0.25
Tape width	W	0.3	16.00
Reel width	W1	1.0	16.50
MPQ/Reel	3000pcs/Reel		

## IMPORTANT NOTES AND DISCLAIMER

1. **ROHS COMPLIANCE:** The levels of RoHS restricted materials in this product are below the maximum concentration values (also referred to as the threshold limits) permitted for such substances, or are used in an exempted application, in accordance with EU RoHS Directive (EU) 2015/863 EC (RoHS3). RoHS Test Report for this product can be obtained at Download Center.
2. **REACH COMPLIANCE:** REACH substances of high concern (SVHCs) information is available for this product. Since the European Chemical Agency (ECHA) has published notice of their intent to frequently revise the SVHC listing for the foreseeable future, REACH Test Report for this product can be obtained at Download Center.
3. All Product parametric performance is indicated in the Electrical Characteristics for the listed herein test conditions, unless otherwise noted. Product performance may not be indicated by the Electrical Characteristics if operated under different conditions.
4. NextGen Component, Inc (*NextGen*) reserves the right to make changes to this document and its products and specifications at any time without notice. Customers should obtain and confirm the latest product information and specifications before final design, purchase or use.
5. *NextGen* makes no warranty, representation or guarantee regarding the suitability of its products for any particular purpose, not does *NextGen* assume any liability for application assistance or customer product design.
6. *NextGen* does not warrant or accept any liability with products which are purchased or used for any unintended or unauthorized application. No license is granted by implication or otherwise under any intellectual property rights of NextGen.
7. *NextGen* products are not authorized for use as critical components in life support devices or systems without express written approval by *NextGen*.
8. *NextGen* requires that customers first obtain an RMA (Returned Merchandise Authorization) number prior to returning any products. Returns must be made within 30 days of the date of invoice, be in the original packaging, unused and like-new condition. At the time of quoting or purchasing, a product may say that it is Non-Cancelable/ Non-Returnable (NCNR). These products are not returnable and not refundable.