

Industrial Cabling

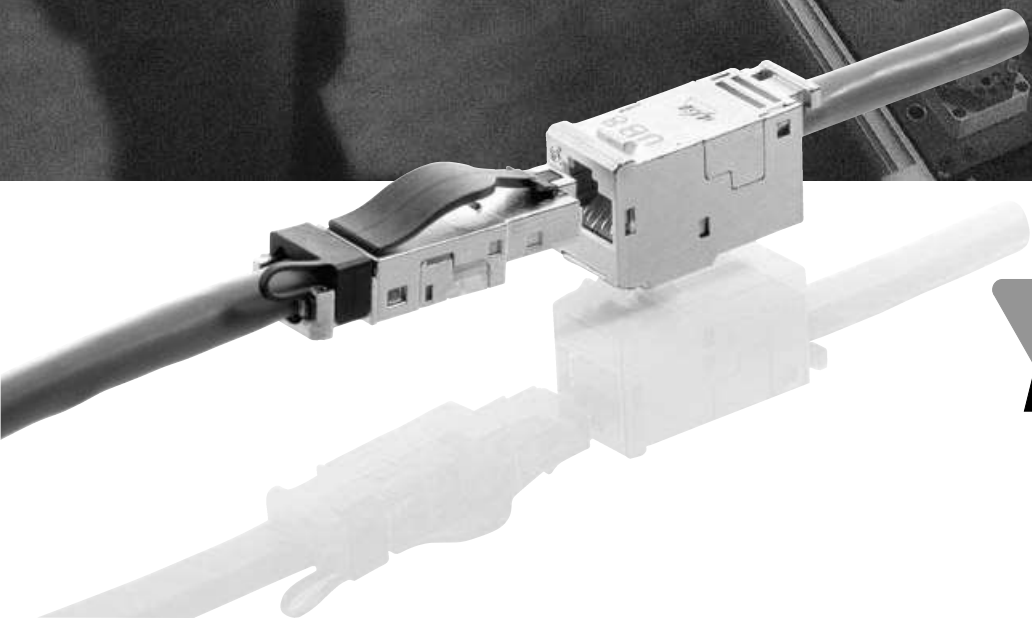

BTR NETCOM
... and your net works

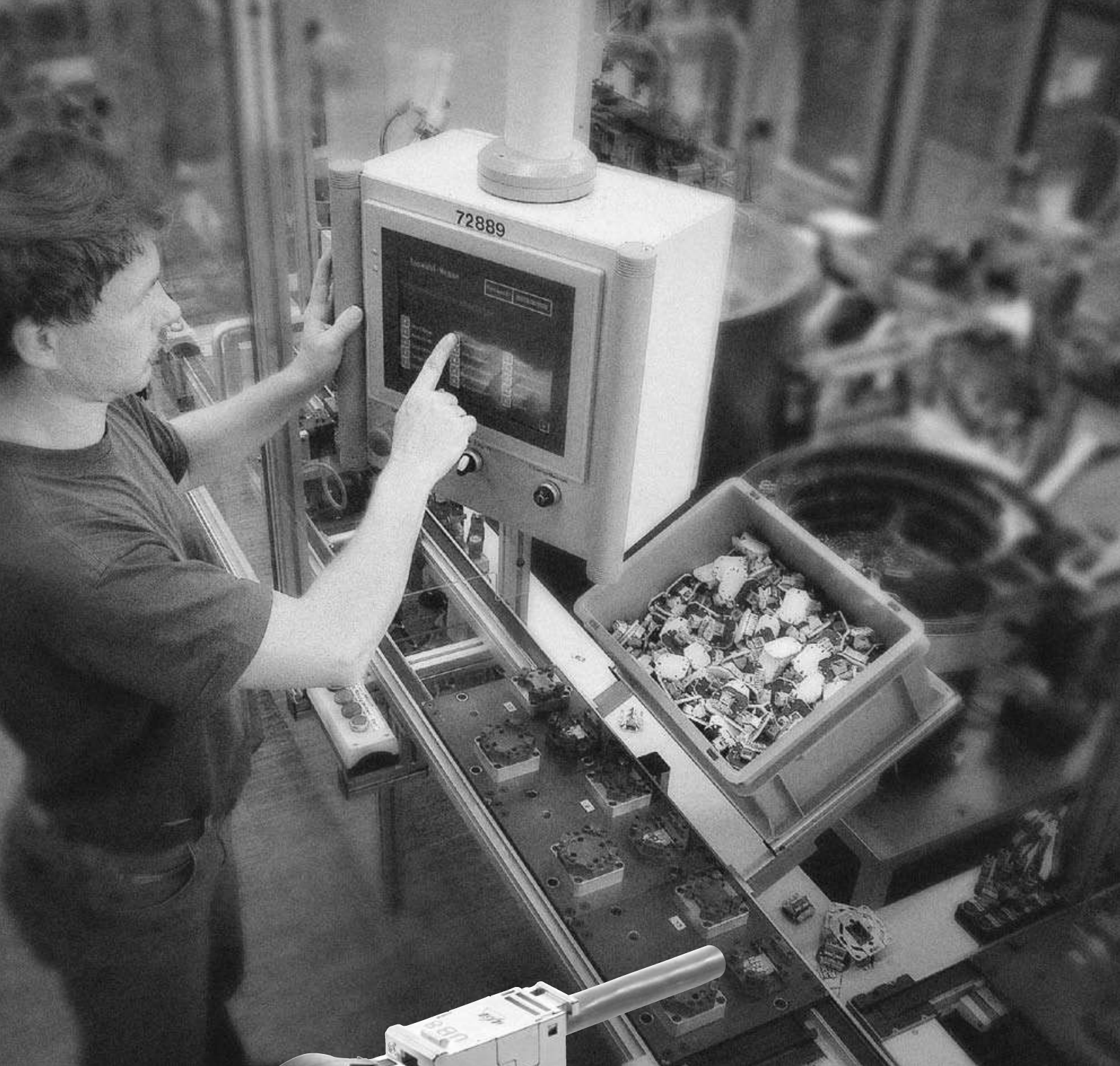

Description	Page
Performance features	Page 2
Single port modules Cat.6	Page 5
Extension and accessory modules	Page 6
DIN rail module Cat.6	Page 7
Cat.6 components with IP20/44 protection	Page 8

- + Cat.6 12C-de-embedded
- + tool free IDC termination
- + fully shielded single port modules
- + rapid mounting
- + for 10Gbit Ethernet

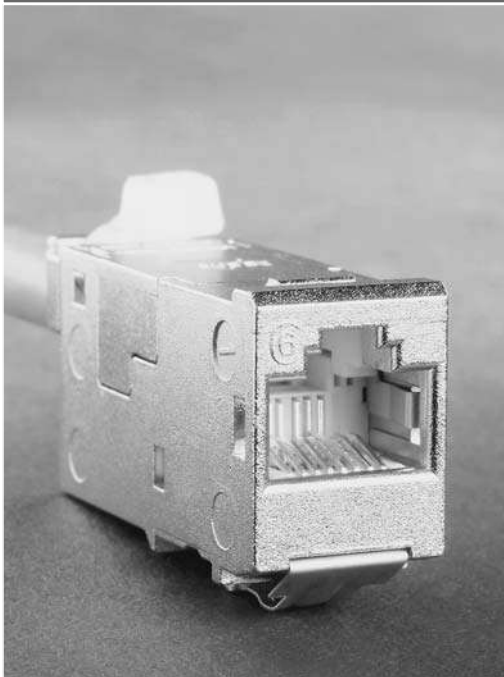

Product Description

The principal item of the E-DAT modul Cat.6/Class E termination system is the E-DAT modul. With its excellent transmission rates, its solid die-cast zinc metal housing, the intelligent wire management and the integrated 360 degree shield connectivity with separate strain relief this compact RJ45 termination module meets the requirements for modular high quality termination technology. The individual shielding of the RJ45 ports and direct ground connection of the modules to the module support produce excellent EMI features. The compact design of the modules allows high density packaging in many applications such as 24 port patch panels, 3 port wall outlets and in 6 to 12 port E-DAT subway units. The extraordinary mounting ease requiring no special tools is provided by the easy and quick pair wise wire application, the BTR IDC contact system and a housing with only two parts.

What's well proven in the office is more and more used in other applications, too. Especially in the area of industrial applications the focus lies now on IT technologies. BTR has seized this trend and adapted the well-established and proven office components to fit industrial areas. The user's aim is an integrated solution from the office to the machine. BTR has met this challenge and designed an integrated cabling system for office and industry based on the product line E-DAT modul.

General Product Features

- Cat.6 12C-de-embedded tested per EN 50173-1:2002 and certified by GHMT
- Class E up to 250 MHz (on all pin/pair assignments) per ISO/IEC 11801:9/2002 and EN 50173-1:2002
ACR > 30 dB at 100 MHz
ACR > 10 dB at 250 MHz
- qualified for 10 GBit Ethernet (IEEE 802.3an draft) up to 100 m
- time-saving and easy mounting
- fully closed metal housing
- individually shielded RJ45 modules
- module housing consisting of only two parts
- applications for nearly every field of application
- complete shielding of all cable and plug connections
- EMC-safe per EN 55022-B, EN 50082-1
- separate shield connectivity and strain relief
- large sized 360° shield connection
- reproducible installation quality
- mounting friendly termination of the 2 to 4 pair data lines AWG 22/24 and stranded wires with 7 conductor copper wire AWG 26/7 to BTR eightfold ID connectors
- wire colour identification per TIA/EIA 568A
- captive connectivity clamp for cable shield
- pin/pair assignment per ISO/IEC 11801/EN 50173-1; the wire pairs can pass up to the terminal block without untwisting the pairs
- reusable modules (see Technical Data), easy to open

Note: the mentioned classes and categories refer to the following standards.

Cat.7	per ISO/IEC 11801:9/2002 and EN 50173-1:2002
Cat.6	per ISO/IEC 11801:9/2002 and EN 50173-1:2002
Cat.6 Link	per TIA/EIA 568B2
Cat.3	per ISO/IEC 11801:9/2002 and EN 50173-1:2002
Class E	per ISO/IEC 11801:9/2002 and EN 50173-1:2002



E-DAT modul Linkperformance 10 GBit Ethernet up to 100 m

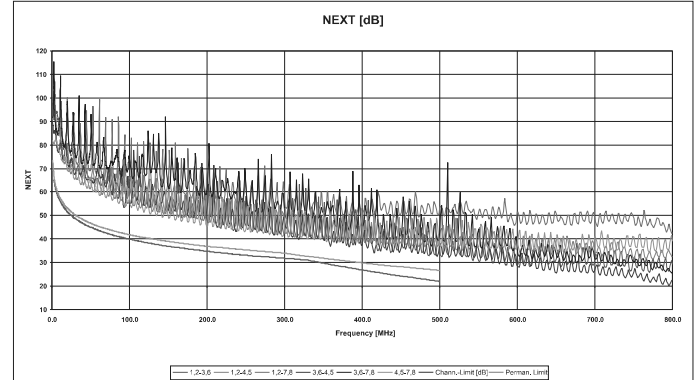

E-DAT modul 8(8) Cat.6 jack

- mounting friendly termination of the 2 to 4 pair data lines AWG 22/24 and stranded wires with 7 conductor copper wire AWG 26/7 to BTR eightfold ID connector
- wire colour identification per TIA/EIA 568A
- easy and rapid insertion of the wire pairs to the E-DAT modul loader
- metal module housing made of refined die-cast zinc
- mounting requires no special tool
- strain relief by cable ties at the module

E-DAT modul coupler 8(8) Cat. 6

- Class E / Cat.6 Link
- fully shielded coupler with metal housing
- especially suited for consolidation points and cross-connect cabling
- 2 mounting types in one coupler, fits in E-DAT modul and keystone applications
- low installation depth due to cable outlet direction of 90 degree
- matching E-DAT modul applications: E-DAT modul wall outlets, E-DAT Industry IP67 mounting flanges, E-DAT modul REG, E-DAT modul module frames and E-DAT subway

E-DAT modul coupler 8(8) 90° Cat. 6

- Class E / Cat.6 Link
- fully shielded 90 degree coupler with metal housing
- allows connections in a 90 degree angle
- especially suited for customized solutions such as consolidation points
- 2 mounting types in one coupler, fits in E-DAT modul and keystone applications
- low installation depth due to cable outlet direction of 90 degree
- matching E-DAT modul applications: E-DAT modul wall outlets, E-DAT Industry IP67 mounting flanges

E-DAT modul extension and accessory modules

The extension modules integrate to our well-proven E-DAT modul applications such as E-DAT modul patch panels, E-DAT modul wall outlets, the E-DAT subway system, the E-DAT modul REG, E-DAT Industry IP67 (surface mount wall outlet, cable coupler, mounting flange) and E-DAT modul IP44 wall outlets.

Performance features

E-DAT modul REG 8(8) IP20

- termination unit with/for one module mounts on TH35 rail per DIN EN 60715
- the width of 1TE allows mounting of up to 12 REG modules into a standard electrical distributor
- when mounted as a device of protection class I the potential balance is provided by the integrated potential balance spring directly via the rail, connect the spring by appropriate connectivity clamps to the potential balance of the building
- the module is protected against direct touch by a cover. When mounted into safety isolated distributors they comply with protection class II. In this case it is necessary to remove the potential balance spring.
- integrated dust protection cover (available in different colours, too)

E-DAT modul 2x8(8) APF

- flat surface mount housing, accepts up to 2 single port modules
- mounts in false floors
- colour coding of ports (red/blue)
- ideal to implement consolidation points

E-DAT modul IP20 Surface Mount Housing

- IP20 surface mount housing for two E-DAT modul Cat.6 8(8) or other extension modules
- top down cable feeding for one or two cables
- shatter-proof
- closed cover with plugged patch cables
- grey colour

E-DAT modul IP44 Surface Mount Housing

- IP44 surface mount housing for two E-DAT modul Cat.6 8(8) or other extension modules
- top down cable feeding for one or two cables
- shatter-proof
- grey colour

E-DAT modul IP44S

- lockable IP44 outlet (is provided with 24 different keys, same key type available on demand)
- outlet cover closes even when patch cables are plugged
- available in two versions, as surface mount housing and as flush mount housing for installation in parapet trunking or for flush mounting in connection with the wall outlet for flush mount installation
- accepts two single port modules E-DAT modul
- ball proof per DIN 18032
- allows operation with standard patch cables
- well visible label window
- bottom part of the surface mount housing is pivotable by 180 degree to allow cable feeding from topside or bottomside
- surface mount version provides space to deposit necessary spare cable
- M25 membrane screw for one cable (6 to 9 mm), an additional M25 2x8 cable screw is available that accepts two cables

Single port modules Cat.6

E-DAT modul Cat.6 8(8)

your part no.	
part no.	130910-I
colour	
type	8(8) TIA-A
EAN	4250184105473

- qualified for 10 GBit Ethernet (IEEE 802.3an draft) up to 100 m

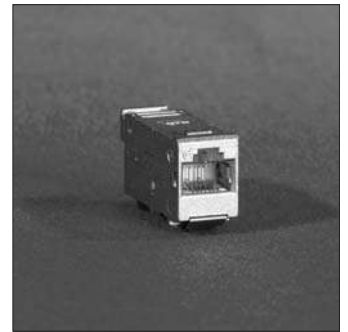

E-DAT modul coupler 8(8) Cat.6

your part no.	
part no.	1309A0-I
colour	
type	8(8) coupler
EAN	4250184106616

Matching E-DAT modul applications

- E-DAT Industry IP67 EbM/EbK, E-DAT modul wall outlets, E-DAT modul REG, E-DAT subway and E-DAT modul module frame

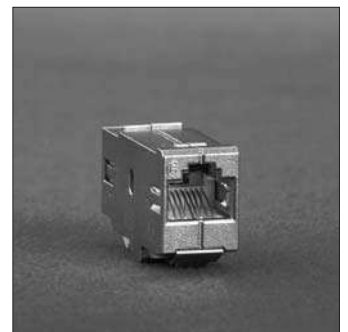

E-DAT modul coupler 8(8) 90° Cat.6

your part no.	
part no.	1309A1-I
colour	
type	8(8) coupler
EAN	4250184106623

Matching E-DAT modul applications

- E-DAT Industry IP67 EbM/EbK and E-DAT modul wall outlets



OpDAT modul LC

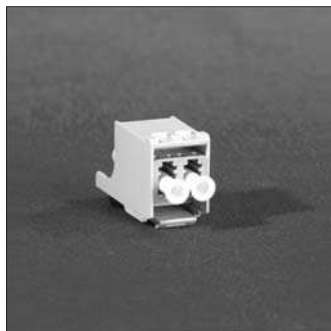

your part no.		
part no.	15091070-I	15091071-I
colour	light grey	light grey
type	LC-D (Ph-Br)	LC-D (ceramic)
EAN	4250184109761	4250184109778

OpDAT modul ST



your part no.	
part no.	15091001-I
colour	light grey
type	ST (ceramic)
EAN	4250184109754

- for SM and MM applications

BLIND modul

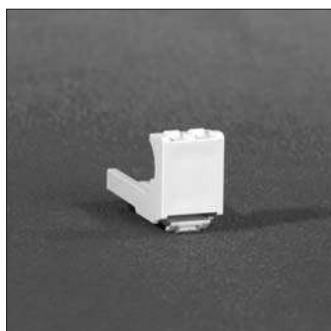

your part no.	
part no.	130898-00-I
colour	light grey
type	empty
EAN	4250184105299

- to close E-DAT modul apertures

E-DAT modul REG 8(8) IP20



your part no.		
part no.	1309426003-E	1309426103-E
colour	light grey	light grey
type	8(8)	empty
EAN	4250184106586	4250184106593

- empty version: accepts the following modules: E-DAT modul coupler 8(8) Cat.6, OpDAT modul and BLIND modul



E-DAT modul 2x8(8) APF

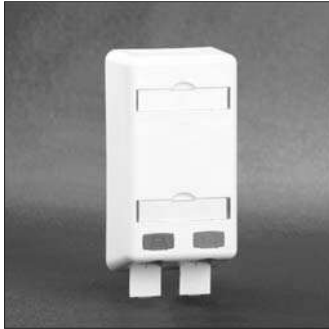

your part no.	
part no.	1309150102-E
colour	pure white
type	without modules
EAN	4250184111238

- empty, accepts 1 or 2 E-DAT modul single port modules
- suited as consolidation point

E-DAT modul IP20 surface mounting housing



your part no.	
part no.	1309450003-E
colour	grey
type	without modules
EAN	4250184112990

- empty, accepts 1 or 2 E-DAT modul single port modules
- protection against dirt and humidity from above
- identical design as the IP44 version, but with cut-out in the cap

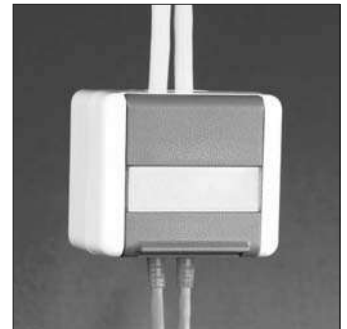

E-DAT modul IP44 surface mounting housing



your part no.	
part no.	1309430003-E
colour	grey
type	without modules
EAN	4250184106609

- unequipped, accepts 1 or 2 E-DAT modul single port modules
- protection against dirt and humidity when no patch cables are plugged

E-DAT modul IP44S surface mounting housing



your part no.	
part no.	1309440003-I
colour	grey
type	without modules
EAN	4250184111153

- unequipped, accepts 1 or 2 E-DAT modul single port modules
- with lock and 2 keys

Screwed cable gland M25 2x8

your part no.	
part no.	130944V203-E
colour	light grey
type	
EAN	4250184111191



- screwed cable gland M25 with two separate cable entries for the E-DAT modul IP44S surface mounting housing

E-DAT modul IP44S flush mounting housing

your part no.		
part no.	1309441003-I	1309441002-I
colour	grey	pure white
type	without modules	without modules
EAN	4250184111177	4250184111160



- unequipped, accepts 1 or 2 E-DAT modul single port modules
- with lock and 2 keys



Flush mounting built-in outlet grey

your part no.	
part no.	1309441903-I
colour	grey
type	
EAN	4250184111184

- builds in the E-DAT modul IP44S flush mounting housing



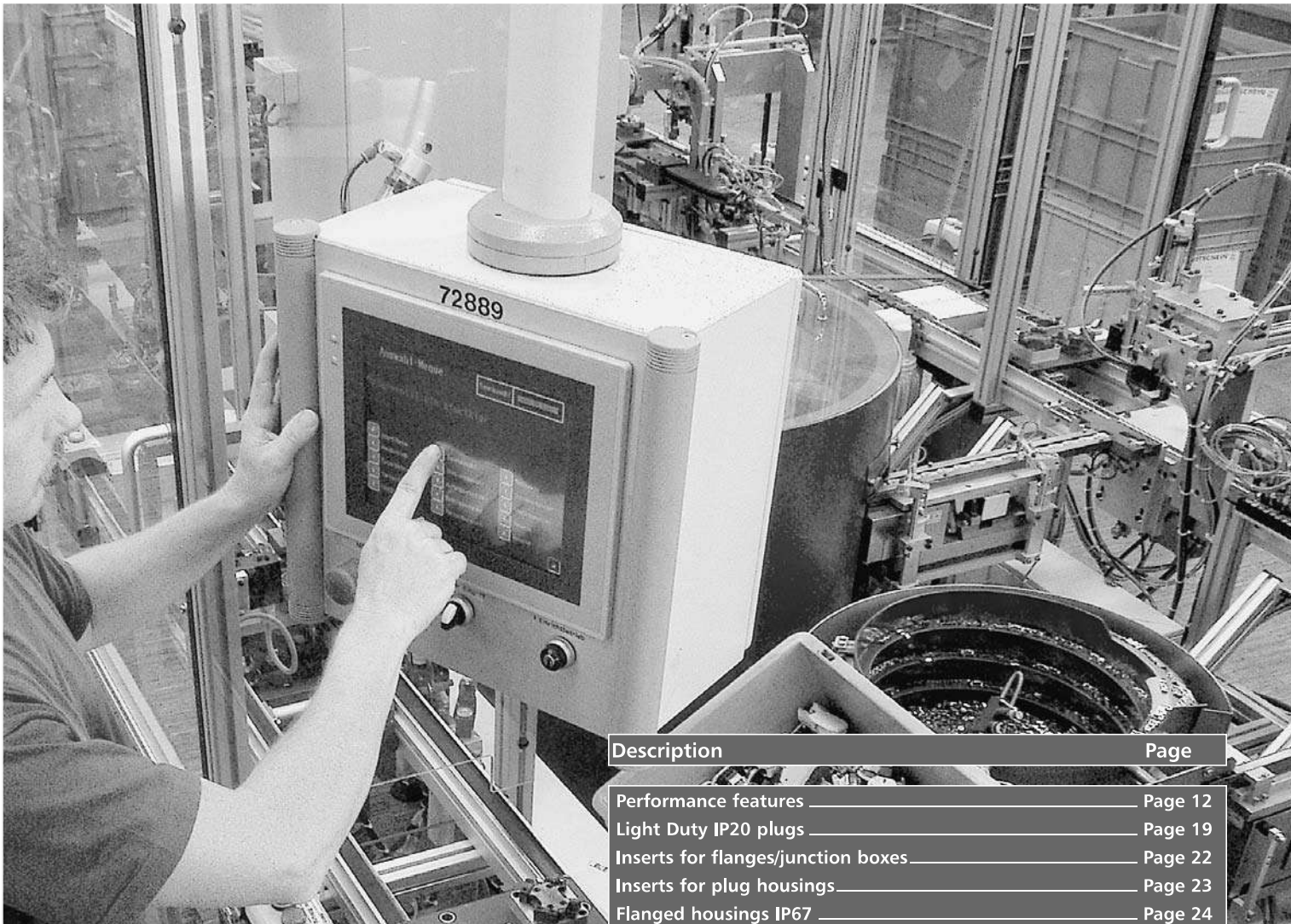

- + Eight-core field assembled RJ45 plugs
- + Simple assembly
- + Suitable for 10 GBits

Description	Page
Performance features	Page 12
Light Duty IP20 plugs	Page 19
Inserts for flanges/junction boxes	Page 22
Inserts for plug housings	Page 23
Flanged housings IP67	Page 24
Junction boxes IP67	Page 26
Plug housings IP67	Page 28
Flange sets	Page 30
Plug sets	Page 32
Patch cables IP67	Page 36
Accessories	Page 37

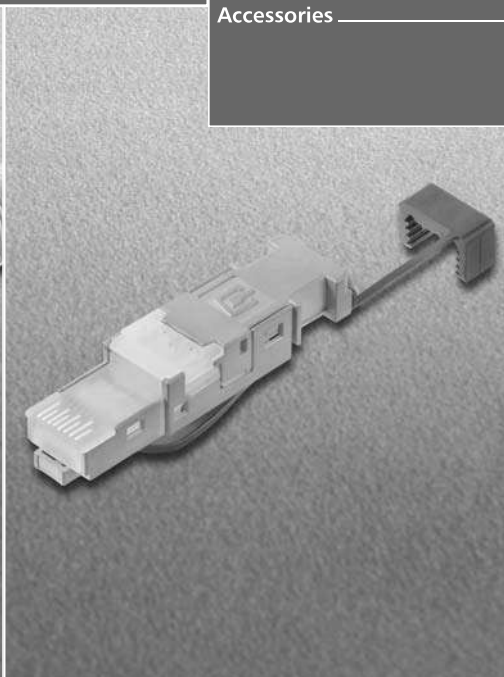

Reliable, simple, fast and designed to resolve problems:

The new range of E-DAT Industry connectors

Plug connectors for modern industrial applications require designs which simplify procedures and which are capable of accommodating accelerated data transmissions. In BTR NETCOM Ethernet connectors, they represent a decisive advance, in that the products are not only capable of handling gigabits, but also comply with the IEC 61076-3-106 standard. The variants 4 and 5 of the connectors specified in this standard (Profinet) and variant 1 (Ethernet IP) are also specified for the ISO/IEC 24702 (FDIS), IEC 61918 (automation island) and IEC 61784-5 standards for cabling systems for unspecified purposes in

industrial buildings. Thanks to a wide choice of 'fit-for-all' inserts, which can be fitted without difficulty in all versions of IP67 housings, a high degree of flexibility arises, not only in the choice of products but also in their applications. On top of all this, you have only to decide between versions made of plastic or metal and inserts for copper or fibre optic cable systems. All connectors, moreover, are designed for rapid, on-site assembly and ease of use - composed of modules and matched to your application.

The 'Fit-for-all' principle

Make good use of the high degree of flexibility on offer. The portfolio will bring decisive advantages to your industrial application from the standpoint of planning, assembly and ongoing operations. All our housings are configured to comply with the IP67 type of protection. Simply choose the requisite insert and the desired material.

Our range of plugs is fully compatible and each insert can be combined with every plug and flanged housing. You can choose between plastic and metal.

Plug inserts

Plug housings

Flanged housings

Flanged inserts

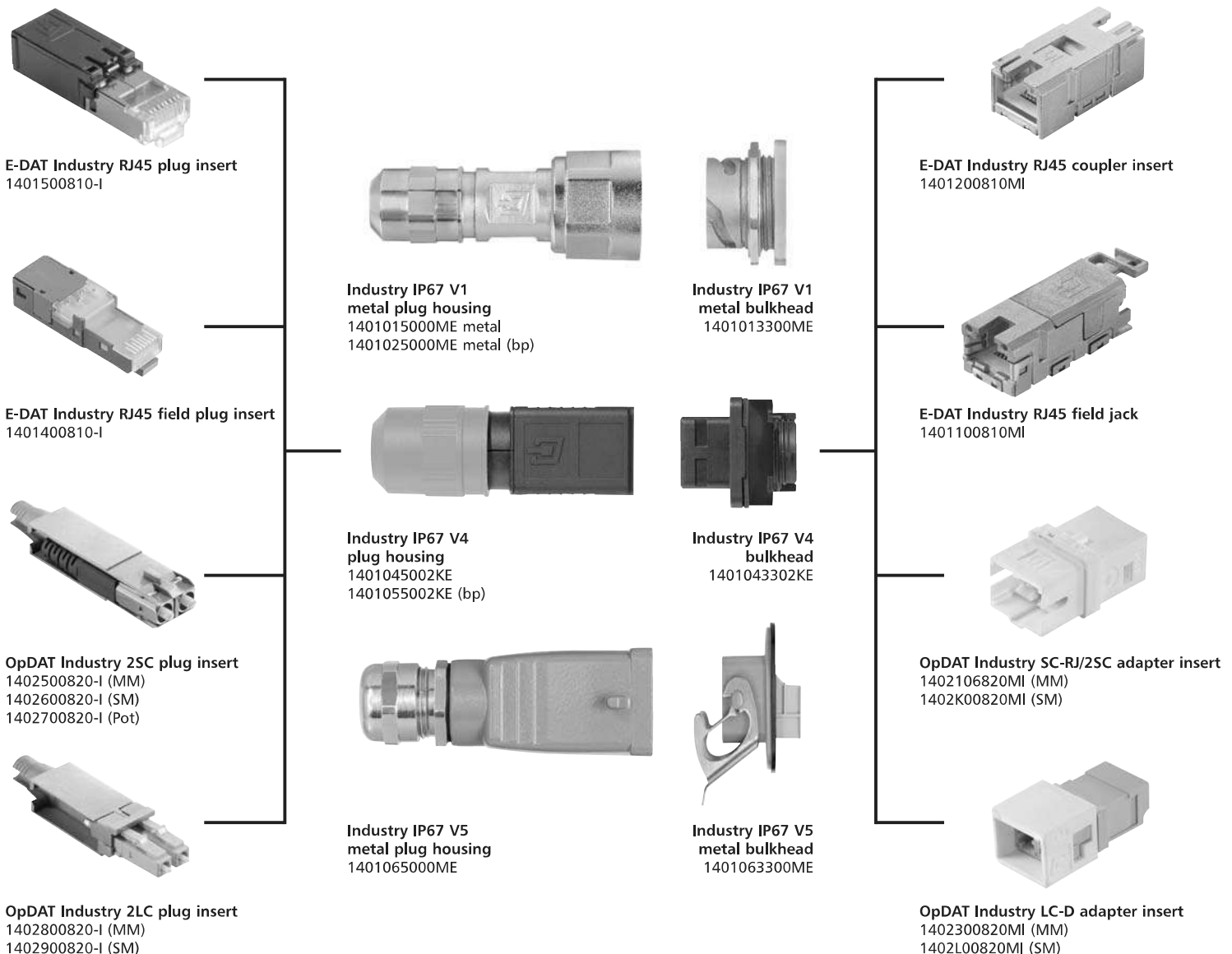



RELIABLE TECHNOLOGY

THE FUTURE OF THE PLUG CONNECTOR

The name *STEADYTEC* stands for forward-looking connecting techniques for use in the fields of data, energy and signal transmissions. Owing its existence to the three leading manufacturers in the industry, the *STEADYTEC* brand name forms the basis for reliable, user-orientated, standardised connectors for use not only in the office but also in the harsh industrial environment.

The *STEADYTEC* technology brand - an overview

STEADYTEC: The claim

In a class of its own from every point of view

Products bearing the '*STEADYTEC* Reliable Technology' label have one thing in common. They comply with all the applicable standards in terms of performance and safety, and stand for unsurpassed reliability in the transmission of optical and electrical signals, resulting in a high level of system serviceability.

STEADYTEC: The concept

One platform for all requirements

Due to their being made in a variety of types and by different manufacturers, housings, plugs, sockets and flanges are often incompatible with each other. *STEADYTEC* offers its users the solution to all requirements, based on a unique platform concept for harsh ambient conditions.

STEADYTEC: The cooperation

Competence to the power of three

Perfect things can only be improved by their being combined with other perfect things. The three leading manufacturers have combined their knowledge of electrical and optical connector technology in the *STEADYTEC* brand and have developed a connector standard for industrial applications offering a considerable variety of customer benefits.

E-DAT Industry

Our products from the E-DAT Industry series fulfil these requirements and are marked with the *STEADYTEC* technology brand name.



General performance features

- One of the most comprehensive ranges on the market: variants 4, 5, 1 and 6
- Protective housing for copper and optical fibres
- Cat.6 continuity, hence suitable for 10 gigabit Ethernet
- Eight-core RJ45 plug (which can be assembled in the field) for AWG 22 in plug variants 4, 5 and 1
- Considerable space-saving through similarly shaped couplers and modules
- Improved vibration and shock resistance through four springs on the shielding plates in the RJ45 module and coupler sockets
- POF, PCF and glass in variants 4 and 1 with SC inserts
- Cable sheaths of increased diameter in the plug of variants 4 and 1
- Reduced risk of contaminant deposits on the plug of variants 4 and 1
- Snap-on clips for colour coding of light- and heavy-duty plugs after assembly

E-DAT Industry IP20 RJ45 plug

- Cat.6
- Suitable for 10 GBits as per IEEE 802.3an draft
- 27/7-24/7 and AWG 24/1 can be connected
- Core diameters from 0.85 to 1.05 mm
- Cable sheaths up to 7.3 mm can be connected
- Connection of crimp contacts and shield connection possible with crimping tool in a single pass
- Multipoint capability
- Retrofit (also exchangeable) anti-kink sleeve
- Effective grip contours
- Supplementary snap-on clip for colour coding
- Possibility of differently coloured upper section (alternative to colour coding)
- Flared glands to protect connecting cable from bending
- Can be used as a test plug on the IP67 side of variants 4, 5, 1 and 6

E-DAT Industry IP20 RJ45 field plug black

- Cat.6
- Suitable for 10 GBits as per IEEE 802.3an draft
- Eight-core RJ45 plug (which can be assembled in the field) for AWG 22
- Plug consists of only two parts
- Straightforward assembly - make connections without special tools
- AWG 26/7-22/7, AWG 24/1-22/1 can be connected
- On assembly, the cable is physically secured to the charging stage
- Easily fitted cable grip
- Cable grip can be snapped on as colour coding after assembly
- Cable sheaths from 5.5 to 8.5 mm
- Industry-compatible diecast zinc housing
- Multipoint capability
- Protected locking hook
- Can be used as a test plug on the IP67 side of variants 4, 5, 1 and 6

OpDAT Industry IP20 SC / LC-D plug

- Assembly on site with tools and aids supplied
- Short polishing times, thanks to preformed convex end-face
- Outstanding optical properties
- High precision and endurance (min. 1000 plug-in cycles)
- Ceramic ferrules
- Complies with applicable international standards

E-DAT Industry IP20 bend protection

- Anti-kink sleeve for E-DAT Industry IP20 plug
- Available in white, grey, blue, yellow, green and black
- Flared glands protect connecting cable from bending
- Can be retrofitted
- Effective grip contours

Industry colour coding ring field plug

- Easily fitted, coloured cable grip; fits E-DAT Industry IP20 RJ45 field plug
- Can be fitted after plug assembly
- In white, grey, orange, blue, yellow and green

OpDAT Industry SC-RJ / SC-D bracket

- Retaining frame for the integration of two standard SC-simplex at a distance from an SC-RJ (blue)
- Retaining frame for the integration of two standard SC-simplex at a distance from an SC-D (beige)

E-DAT Industry RJ45 coupler insert

- Cat.6
- Exceptionally compact design
- Symmetrical shape, can be installed in any position
- Can be mounted from the front in conjunction with the flange (IP67)
- FS 2.8 ground connection for equipotential bonding at both ends
- Increased vibration and shock resistance through four springs on the shielding plates
- High-strength diecast zinc housing

E-DAT Industry RJ45 field Jack insert

- Cat.6
- Versions for connection in accordance with TIA-A, TIA-B or PROFINET
- Eight-core RJ45 module (can be assembled in the field); no special tools required
- AWG 27/7-22/7; AWG 24/1-22/1 can be connected
- No projecting contours
- 2 x FS 2.8 mm ground connections for equipotential bonding at cable end
- Increased vibration and shock resistance through four springs on the shielding plates
- Easy to assemble and install in variants 4, 5 and 1.
- Consists of only two parts
- Can be mounted from the front in conjunction with the flange (IP67)
- High-strength diecast zinc housing

OpDAT Industry SC-RJ/2SC and LC-D adapter inserts

- Can be integrated in flange or junction box of variants 4 and 1.
- SC and SC-RJ compatible on IP 20 side
- Available for LC-D in MM and SM versions
- Available for SC-RJ/2SC in MM, SM and POF versions

E-DAT Industry RJ45 plug insert

- Cat.6
- Suitable for 10 GBits as per IEEE 802.3an
- AWG 27/7-24/7 and AWG 24/1 can be connected
- Core diameters from 0.85 to 1.05 mm
- Cable sheath up to 7.3 mm
- Without locking lever
- Connection of crimp contacts and shield connection possible with crimping tool in a single pass

E-DAT Industry RJ45 field plug insert

- Cat.6
- Suitable for 10 GBits as per IEEE 802.3an draft
- Eight-core RJ45 plug (can be assembled in the field) for AWG 22
- Consists of only two parts
- Straightforward assembly, no special tools needed
- AWG 26/7-22/7, AWG 24/1-22/1 can be connected
- Easy to install in plug housing of variants 1, 4 and 5
- Industry-compatible diecast zinc housing

Performance features

OpDAT Industry 2SC and 2LC plug inserts

- Can be assembled in the field with standard tools for fibre optic assemblies
- Cable grip from breakout and mini-breakout cables can be crimped on
- Robust diecast zinc designs
- Safe handling of assembled LC plug when installing

Industry IP67 V4 bulkhead

- Flange complying with ISO/IEC 24702, IEC 61076-3-106 variant 4, EN 50173-1:2006 and EN 50173-3:2006 standards
- Easy to install, thanks to round wall sockets with commercially available socket pliers (diameter 22.5 mm)
- Only one version for central screw mounting and alternative with four screws (M3)
- Industry-compatible plastic housing with improved durability
- Flammability category as per UL94V-0
- High resistance to chemicals
- Grounding possible through flat 2.8 mm plug on the insert
- One version to accommodate all flanged inserts
- Labelling possible on flange

Industry IP67 V5 metal bulkhead

- Flange complying with IEC 61076-3-106, variant 5 standard
- Strong, industry-compatible metal housing
- Flammability category as per UL94V-0
- High resistance to chemicals
- Grounding possible through flat 2.8 mm plug on the insert
- One version to accommodate all RJ45 flanged inserts

Industry IP67 V1 metal bulkhead

- Flange complying with ISO/IEC 24702 and IEC 61076-3-106 variant 1 standards
- Easy to install, thanks to round wall sockets and commercially available socket pliers
- Only one version for central screw mounting
- Can be installed on either side
- Industry-compatible metal housing with improved durability
- Flammability category as per UL94V-0
- High resistance to chemicals
- Grounding possible through flat 2.8 mm plug on the insert
- One version to accommodate all flanged inserts

E-DAT Industry IP67 V6 built-in flange EbM and EbK

- EbM for installation of modules from the E-DAT modular product range
- EbK for installation of modules with Keystone face (hole cutout: 14.91 x 19.45 mm)
- Complies with type of protection IP67 when plugged in
- Plug-in face as per IEC 61076-3-106 (variant 6)
- Connection to commercially available RJ45 plugs possible (no IP protection)
- Easy to install
- Versions available with or without high strength, diecast zinc counterplate (also available as an accessory)
- Colour: light grey, RAL 7035

E-DAT Industry IP67 V4, 5, 1 metal outlet K11, K21

IP67 junction boxes offer flexible connecting facilities for networks in the industrial environment

- Available in variants 4, 5 and 1
- Suitable for wall or floor mounting
- AL-Si 12 aluminium housing
- Durable powder coating in RAL 7001
- With 1 or 2 ports
- With outgoing directions straight and to the right

E-DAT Industry IP67 V6 junction box and cable coupler

- Connecting unit with one E-DAT module
- Complies with type of protection IP67 when plugged in
- Plug-in face as per IEC 61076-3-106 (variant 6)
- Generous 360° shield contact-making
- Can be surface mounted in rows
- Connection of commercially available RJ45 plug possible (no IP protection)
- Straightforward, time-saving installation
- Colour: light grey, RAL 7035

Industry IP67 V4 plug housing (bend protected)

- IP67 protected housing complying with ISO/IEC 24702, IEC 61076-3-106 variant 4, EN 50173-1-2006 and EN 50173-3: 2006 standards to accommodate industrial plug inserts
- Increased cable sheath diameter range of 10 mm can be connected
- Versions with and without anti-kink sleeve
- Reduced risk of contaminant deposits and resistant to welding beads
- Choice of industry-compatible plastic or metal housing with increased durability
- Flammability category as per UL 94V-0
- High resistance to chemicals
- Snap-on clip for colour coding after assembly
- With mechanical coding as an alternative
- One-piece plug housing
- Cable can be pushed through preassembled plug housing

Industry IP67 V5 metal plug housing

- Plug housing complying with IEC 61076-3-106 variant 5 standard
- Strong, industry-compatible metal housing
- Flammability category as per UL 94V-0
- High resistance to chemicals
- One version to accommodate RJ45 plug inserts
- Reduced risk of contaminant deposits and resistant to welding beads

Industry IP67 V1 metal plug housing (bend protected)

- Plug complying with ISO/IEC 24702 and IEC 61076-3-106 variant 1 standards
- IP67 protected housing to accommodate industrial plug inserts
- Increased cable sheath diameter range of 10 mm can be connected
- Resistant to welding beads
- Choice of industry-compatible plastic or metal housing with increased durability
- Flammability category as per UL 94V-0
- Improved resistance to chemicals
- Snap-on clip for colour coding after assembly
- Optional anti-kink sleeve in plastic and metal
- Cable can be pushed through preassembled plug housing

E-DAT Industry IP67 V4 bulkhead RJ45 coupler/field jack

- Flange complying with ISO/IEC 24702, IEC 61076-3-106 variant 4, EN 50173-1:2006 and EN 50173-3:2006 standards
- Cat.6
- Versions with RJ45 coupler or RJ45 module (can be assembled in the field)
- Inserts with robust diecast zinc housings
- With flat 2.8 mm plug ground connection for equipotential bonding on insert possible
- Increased vibration and shock resistance through four springs on the shielding plates
- Easy to install, thanks to round wall sockets and commercially available socket pliers (diameter 22.5 mm)
- Only one version for central screw mounting and alternative with four screws (M3)
- Industry-compatible plastic housing of increased durability
- Flammability category as per UL 94V-0
- High resistance to chemicals
- Labelling possible on flange

OpDAT Industry IP67 V4 bulkhead SC-RJ/2SC and LC-D

- Flange complying with ISO/IEC 24702, IEC 61076-3-106 variant 4, EN 50173-1:2006 and EN 50173-3:2006 standards
- Increased vibration and shock resistance
- Easy to install, thanks to round wall sockets and commercially available socket pliers (diameter 22.5 mm)
- Only one version for central screw mounting and alternative with four screws (M3)
- Industry-compatible plastic housing of increased durability
- Flammability category as per UL 94V-0
- High resistance to chemicals
- Labelling possible on flange
- SC variants: SC and SC-RJ compatible on IP20 side
- Available for SC-RJ/2SC in MM, SM and POF versions
- LC variants: IP20 side, LC-D compatible
- Available for LC-D MM and SM versions

E-DAT Industry IP67 V5 metal bulkhead RJ45 coupler/field jack

- Flange complying with IEC 61076-3-106 variant 5 standard
- Cat.6
- Versions with RJ45 coupler or RJ45 module (can be assembled in the field)
- Inserts with robust diecast zinc housings
- With flat 2.8 mm plug grounding connection for equipotential bonding on insert possible
- Increased vibration and shock resistance through four springs on shielding plates
- Insert with robust diecast zinc housing
- High strength, industry-compatible metal housing
- Flammability category as per UL94V-0
- High resistance to chemicals

E-DAT Industry IP67 V1 metal bulkhead RJ45 coupler/field jack

- Flange complying with ISO/IEC 24702 and IEC 61076-3-106 variant 1 standards
- Cat.6
- Versions with RJ45 coupler or RJ45 module (can be assembled in the field)
- Inserts with robust diecast zinc housings
- With flat 2.8 mm plug grounding connection for equipotential bonding on insert possible
- Increased vibration and shock resistance through four springs on shielding plates
- Easy to install, thanks to round wall sockets and commercially available tool for socket pliers
- Can be installed on either side
- Industry-compatible metal housing of increased durability
- Flammability category as per UL94V-0
- Improved resistance to chemicals

OpDAT Industry IP67 V1 metal bulkhead SC-RJ/2SC and LC-D

- Flange complying with ISO/IEC 24702 and IEC 61076-3-106 variant 1 standards
- Increased vibration and shock resistance
- Easy to install, thanks to round wall socket and commercially available tool for socket pliers
- Only one version for central screw mounting
- Can be installed on either side
- Industry-compatible metal housing of increased durability
- Flammability category as per UL94V-0
- Improved resistance to chemicals
- Grounding possible via flat 2.8 mm plug on insert
- SC variants: SC and SC-RU compatible on IP 20 side
- Available for SC-RJ/2Sc in MM, SM and POF versions
- LC variants: IP20 side, LC-D compatible
- Available for LC-D MM and SM versions

OpDAT Industry IP67 2SC built-in flange

- 2SC flange with two electrical jacks for AWG 22-24 can be retrofitted
- Fibre optic IP67 plug system for harsh environments and applications in the industrial sector complying with ISO/IEC 24702 draft
- IP67 built-in flange with M25 x 1.5 screw mounting (nut) or, alternatively, with four M3 screws
- Easy-to-install round installation socket (dia. 25 mm) with notch to prevent twisting
- Suitable for optical fibres SM, MM and POF
- SC and 2SC compatibility on IP 20 side of built-in flange
- Labelling area on rim of built-in flange
- High-strength screw coupler

E-DAT Industry IP67 V4 RJ45 plug

- IP67 protected RJ45 plug complying with ISO/IEC 24702, IEC 61076-3-106 variant 4, EN 50173-1:2006 and EN 50173-3:2006 standards
- Eight-core, cat.6
- Suitable for 10 Gbits as per IEEE 802.3an draft
- AWG 27/7-24/7 and AWG 24/1 can be connected
- Increased cable sheath diameter range of 10 mm
- Reduced risk of contaminant deposits and resistant to welding beads
- Industry-compatible plastic housing of increased durability
- Flammability category as per UL94V-0
- High resistance to chemicals
- Snap-on clip for colour coding after assembly
- Optional plastic anti-kink sleeve
- Alternatively, with mechanical coding
- One-piece plug housing
- Connection of crimped contacts and shield connection possible with crimping tool in a single pass
- Cable can be pushed through preassembled plug housing

Performance features

E-DAT Industry IP67 V4 RJ45 field plug

- IP67 protected housing complying with ISO/IEC 24702, IEC 61076-3-106 variant 4, EN 50173-1:2006 and EN 50173-3:2006 standards
- Cat.6
- Suitable for 10 Gbits as per IEEE 802.3an
- Eight-core RJ45 plug for AWG 22 (can be assembled in the field)
- Higher cable sheath diameter range of 10 mm
- Easy to assemble - make connections without special tools
- AWG 26/7-22/7, AWG 24/1-22/1 can be connected
- Easy to install thanks to round wall socket with commercially available socket pliers (diameter 22.5 mm)
- Only one version for central screw mounting and alternative with four screws (M3)
- Industry-compatible plastic housing of increased durability
- Flammability category as per UL94V-0
- High resistance to chemicals
- Reduced risk of contaminant deposits and resistant to welding beads
- Snap-on clip for colour coding after assembly
- Optional plastic anti-kink sleeve
- One-piece plug housing
- Cable can be pushed through preassembled plug housing

OpDAT Industry IP67 V4 2SC and 2LC plug

- IP67 protected housing complying with ISO/IEC 24702, IEC 61076-3-106 variant 4, EN 50173-1:2006 and EN 50173-3:2006 standards with 2SC or 2LC insert
- Higher cable sheath diameter range of 10 mm
- Reduced risk of contaminant deposits and resistant to welding beads
- Choice of industry-compatible plastic or metal housing of increased durability
- Flammability category as per UL94V-0
- High resistance to chemicals
- Snap-on clip for colour coding after assembly
- Optional plastic anti-kink sleeve
- Alternatively, with mechanical coding
- One-piece plug housing
- Cable can be pushed through preassembled plug housing
- Cable grip from breakout and mini-breakout cables can be crimped on
- Robust diecast zinc design
- Safe handling of assembled LC plug when installing

E-DAT Industry IP67 V5 RJ45 metal plug

- Plug complying with IEC 61076-3-106 variant 5 standard
- Cat.6
- Suitable for 10 Gbits as per IEEE 802.3an draft
- Strong, industry-compatible metal housing
- Resistant to welding beads
- Flammability category as per UL94V-0
- High resistance to chemicals
- AWG 27/7-24/7 and AWG 24/1 can be connected
- Connection of crimp contacts and shield connection possible with crimping tool in a single pass

E-DAT Industry IP67 V5 RJ45 metal field plug

- Plug housing complying with IEC 61076-3-106 variant 5 standard
- Cat.6
- Suitable for 10 Gbits as per IEEE 802.3an
- Eight-core RJ45 plug for AWG 22 (can be assembled in the field)
- Straightforward assembly - make connections without special tools
- Reduced risk of contaminant deposits and resistant to welding beads
- AWG 26/7-22/7, AWG 24/1-22/1 can be connected
- Strong, industry-compatible metal housing
- Flammability category as per UL94V-0
- High resistance to chemicals

E-DAT Industry IP67 V1 RJ45 metal plug

- IP67 protected RJ45 plug complying with ISO/IEC 24702 and IEC 61076-3-106 variant 1 standards
- Cat.6
- Suitable for 10 Gbits as per IEEE 802.3an
- AWG 27/7-24/7 and AWG 24/1 can be connected
- Increased cable sheath diameter range of 10 mm
- Resistant to welding beads
- Choice of industry-compatible plastic or metal housing of increased durability
- Flammability category as per UL94V-0
- Improved chemical resistance
- Snap-on clip for colour coding after assembly
- Optional anti-kink sleeve in plastic and metal
- Connection of crimp contacts and shield connection possible with crimping tool in a single pass
- Cable can be pushed through preassembled plug housing

E-DAT Industry IP67 V1 RJ45 metal field plug

- Eight-core, IP67 protected RJ45 plug (can be assembled in the field) complying with ISO/IEC 24702 and IEC 61076-3-106 variant 1 standards
- Cat.6
- Suitable for 10 Gbits as per IEEE 802.3an draft
- Straightforward assembly - make connections without special tools
- AWG 26/7-22/7, AWG 24/1-22/1 can be connected
- Higher cable sheath diameter range of 10 mm
- Resistant to welding beads
- Choice of industry-compatible plastic or metal housing of increased durability
- Flammability category as per UL94V-0
- Improved chemical resistance
- Snap-on clip for colour coding after assembly
- Optional anti-kink sleeve in plastic and metal
- Cable can be pushed through preassembled plug housing

OpDAT Industry IP67 V1 2SC and 2LC metal plug

- IP67 protected fibre optic plug for 2SC or 2LC complying with ISO/IEC 24702 and IEC 61076-3-106 variant 1 standards
- Increased cable sheath diameter range of 10 mm
- Cable grip from breakout and mini-breakout cables can be crimped on
- Safe handling of assembled LC plug when installing
- Resistant to welding beads
- Industry-compatible metal housing of increased durability
- Flammability category as per UL94V-0
- Improved resistance to chemicals
- Snap-on clip for colour coding after assembly
- Optional anti-kink sleeve in plastic and metal
- Cable can be pushed through preassembled plug housing

E-DAT Industry IP67 V6 plug with locking clip

- Locking clip in installed condition (can be retrofitted)
- Protection against unintentional opening by locking clip (colour versions also available)
- Crimping of inner and outer conductors in a single pass with professional crimping tool

OpDAT Industry IP67 2SC plug

- 2SC plug with two electrical jacks for AWG 22-24 (can be retrofitted)
- IP67 fibre optic plug system for harsh environments and applications in the industrial sector complying with ISO/IEC 24702 draft
- Suitable for optical fibres SM, MM and POF
- Plug can be assembled in the field with SC plug tool
- Plug ferrule protected by spring-loaded sleeve
- High-strength screw coupling
- Plug with uncrushable metal housing, captive screw-mounted IP67 protective cap and eye as pull-in aid
- Preassembled IP67 patch cable available to order

Patch cable IP67 V6

- Fully shielded cat.6 patch cable AWG 27/7 S/FTP with PUR sheath
- Available in two versions (1 x RJ45 and 1 x IP67 or IP67 plug at both ends)
- Two shielded RJ45 plugs
- Connection 1 - 1
- Standard lengths 5, 10, 15 and 20 m
- Cat.6/Class E approved as per ISO/IEC 11801 and EN 50173-1
- Anti-kink sleeve, grey, with protective locking hook coating (RJ45 end)
- Cable colour: red

Industry IP67 V1 and V4 plug protective cap

- High level of protection even in unplugged condition, thanks to impervious IP67 protective cap
- Flammability category as per UL 94V-0
- Improved resistance to chemicals
- Captive, attached protective cap
- Grip facility for pulling off

Industry colour coding ring V1/V4

- Colour coding rings suitable for V1 and V4 plugs
- Can be installed after plug assembly
- In white, grey, orange, blue, yellow and green

Plier wrench 1 3/8"

- Parallel-jaw wrench for sealing E-DAT modules, E-DAT Industry field jacks and E-DAT Industry field plugs
- Very easy to use

E-DAT Industry V6 locking clip for IP67 plug

- Locking clip, can be retrofitted in installed condition
- Protected against unintentional opening by locking clip, available in yellow, pale grey, green, red and blue

Dismantle tool for copper cable

- Insulation stripping tool for copper cables
- Very easy to use

Assembly pliers for E-DAT Industry IP20 RJ45 plug

- Connection of crimp contacts and shielding connection possible with crimping tool in a single pass
- Supplied in plastic case

Cat.7 cable connector IP67

For the connection/extension of cat.5, cat.6 and cat.7 data cables (PUR).

The temperature limit permitted for the data cable must not be exceeded in the shrink fitting process.

- Category E as per ISO/IEC 11801:2002 is fulfilled in conjunction with cat.7 cables and cat.6 connectors
- Cable feed from two ends
- Cable sharing, possible separation of a single 8-core cable into two 4-core cables
- Fully shielded metal housing
- Cable grip and separate 360° captive shield connection
- IP67 protection through shrink-fit sleeve

Screwdriver bulkhead V4

- Socket wrench to secure central screw coupling of V4 bulkhead

E-DAT Industry IP20 RJ45 plug

your part no.		
part no.	1401505012-E	1401505010-E
colour	black	
type	8(8) plug	w/o snagless boot
EAN	4250184113799	4250184113805



E-DAT Industry IP20 RJ45 field plug black

your part no.	
part no.	1401405012-I
colour	black
type	8(8) field plug
EAN	4250184113881

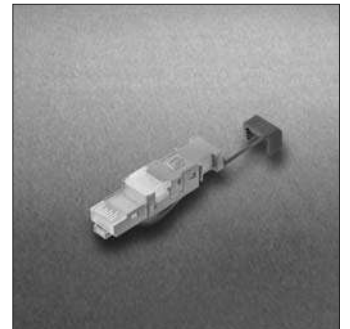

OpDAT Industry IP20 SC plug



your part no.			
part no.	1402F05020-I	1402G05020-I	1402H05020-I
colour			
type	SC (MM)	SC (SM)	SC (POF)
EAN	4250184115847	4250184115854	4250184115861

- One SC-RJ plug or SC-D plug can be made from two IP20 SC plugs with the aid of the OpDAT Industry SC-RJ/SC-D bracket



OpDAT Industry IP20 LC-D plug

your part no.		
part no.	1402805020-I	1402905020-I
colour		
type	LC-D (MM)	LC-D (SM)
EAN	4250184113942	4250184113966



E-DAT Industry IP20 bend protection



your part no.					
part no.	1401008204-E	1401008203-E	1401008206-E	1401008205-E	1401008207-E
colour	white	light grey	blue	yellow	green
type					
EAN	4250184113812	4250184113829	4250184113843	4250184113850	4250184113867

your part no.	
part no.	1401008202-E
colour	black
type	
EAN	4250184113874

Industry colour coding ring field plug

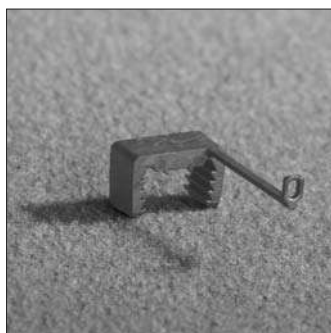

your part no.					
part no.	1401009104-I	1401009103-I	1401009101-I	1401009106-I	1401009105-I
colour	white	light grey	orange	blue	yellow
type	plastic	plastic	plastic	plastic	plastic
EAN	4250184115168	4250184115175	4250184115182	4250184115199	4250184115205

your part no.	
part no.	1401009107-I
colour	green
type	plastic
EAN	4250184115212

OpDAT Industry SC-RJ bracket blue



your part no.	
part no.	140200A006-I
colour	blue
type	SC-RJ
EAN	4250184116691

- With the aid of the retaining clips, one SC-RJ plug can be made from two IP20 SC plugs

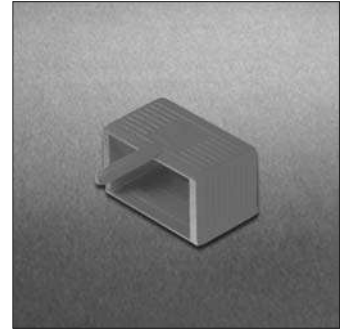

OpDAT Industry SC-D bracket beige

your part no.	
part no.	140200A100-I
colour	beige
type	SC-D
EAN	4250184113980

- With the aid of retaining clips, one SC-D plug can be made from two IP20 SC plugs

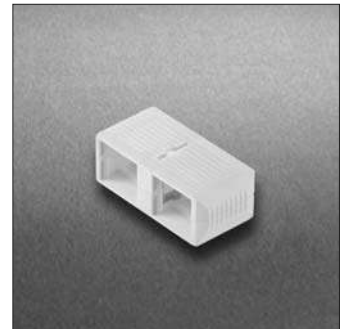

E-DAT Industry RJ45 coupler insert

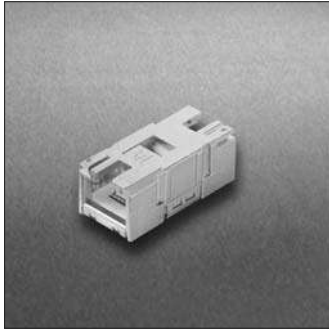

your part no.	
part no.	1401200810MI
colour	
type	8(8) coupler
EAN	4250184114260

- For installation in IP67 flanged housings and IP67 junction boxes of variants 4, 5 and 1

E-DAT Industry RJ45 field jack insert

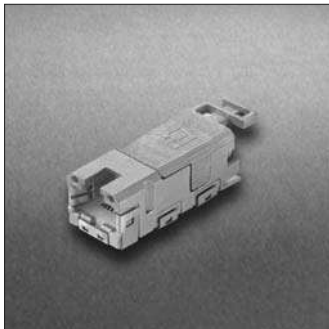

your part no.			
part no.	1401100810MI	1401800810MI	1401900810MI
colour			
type	8(8) TIA-A	8(8) TIA-B	Profinet
EAN	4250184114277	4250184116578	4250184116561

- For installation in IP67 flanged housings and IP67 junction boxes of variants 4, 5 and 1

OpDAT Industry SC-RJ/2SC adapter insert



your part no.		
part no.	1402100820MI	1402K00820MI
colour		
type	SC-RJ/2SC (MM)	SC-RJ/2SC (SM)
EAN	4250184114284	4250184115892

- For installation in IP67 flanged housings and IP67 junction boxes of variants 4 and 1
- SC-RJ/2SC (MM) version also suitable for POF

OpDAT Industry LC-D adapter insert

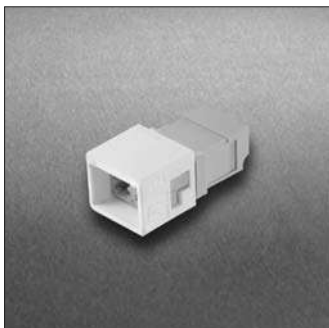

your part no.		
part no.	1402300820MI	1402L00820MI
colour		
type	LC-D (MM)	LC-D (SM)
EAN	4250184114291	4250184115908

- For installation in IP67 flanged housings and IP67 junction boxes of variants 4 and 1
- LC-D (MM) version also suitable for POF

E-DAT Industry RJ45 plug insert

your part no.	
part no.	1401500810-I
colour	
type	8(8) plug
EAN	4250184114109

- For installation in IP67 plug housings of versions 4, 5 and 1



E-DAT Industry RJ45 field plug insert

your part no.	
part no.	1401400810-I
colour	
type	8(8) field plug
EAN	4250184114116

- For installation in IP67 plug housings of versions 4, 5 and 1

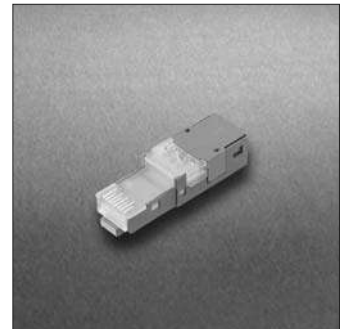

OpDAT Industry 2SC plug insert

your part no.			
part no.	1402500820-I	1402600820-I	1402700820-I
colour			
type	2SC (MM)	2SC (SM)	2SC (POF)
EAN	4250184114000	4250184114123	4250184114130

- For installation in IP67 plug housings of versions 4 and 1



OpDAT Industry 2LC plug insert

your part no.		
part no.	1402800820-I	1402900820-I
colour		
type	2LC (MM)	2LC (SM)
EAN	4250184114147	4250184114178

- For installation in IP67 plug housings of versions 4 and 1

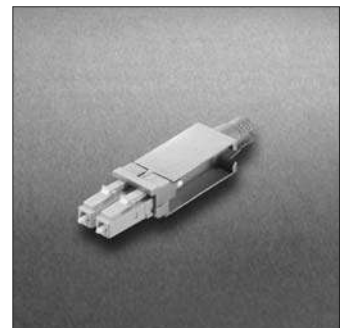

Industry IP67 V4 bulkhead



your part no.	
part no.	1401043302KE
colour	black
type	empty
EAN	4250184114215

- To accommodate E-DAT Industry RJ45 coupler/field jack insert and OpDAT Industry SC-RJ/2SC and LC-D adapter insert

Industry IP67 V5 metal bulkhead



your part no.	
part no.	1401063300ME
colour	
type	empty
EAN	4250184114222

- To accommodate E-DAT Industry RJ45 coupler/field jack insert

Industry IP67 V1 metal bulkhead

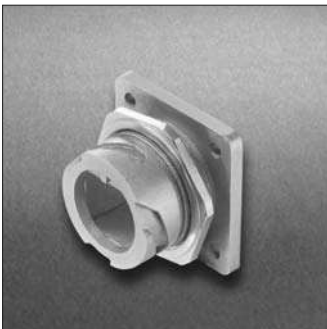

your part no.	
part no.	1401013300ME
colour	
type	empty
EAN	4250184114239

- To accommodate E-DAT Industry RJ45 coupler/field jack insert and OpDAT Industry SC-RJ/2SC and LC-D adapter insert

E-DAT Industry IP67 V6 8(8) EbM



your part no.			
part no.	1309413003-E	1309413203-E	130910-I
colour	light grey	light grey	
type	empty	mounting kit	8(8) TIA-A
EAN	4250184106531	4250184106555	4250184105473

- Suitable for E-DAT module cat.6 8(8), E-DAT module coupling 8(8) cat.6, E-DAT module coupling 8(8) 90° cat.6
- Version with installation kit; counterplate made of high-strength diecast zinc

Flanged housings IP67

E-DAT Industry IP67 V6 8(8) EbK

your part no.			
part no.	1309413103-E	1309413303-E	1309A0-I
colour	light grey	light grey	
type	empty	mounting kit	8(8) coupler
EAN	4250184106548	4250184106562	4250184106616

- Suitable for Keystone modules and couplers
- Version with installation kit; counterplate made of high-strength diecast zinc



E-DAT Industry IP67 V4 2port metal outlet

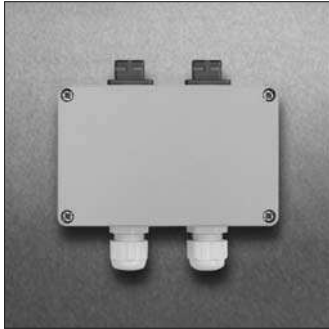

your part no.			
part no.	1401040110ME	1401040220ME	1401040620ME
colour			
type	1 Port straight	2 Port right	2 Port straight
EAN	4250184116394	4250184116400	4250184116417

- To accommodate E-DAT Industry RJ45 coupler/field jack insert and OpDAT Industry SC-RJ/2SC and LC-D adapter insert

E-DAT Industry IP67 V5 1port metal outlet

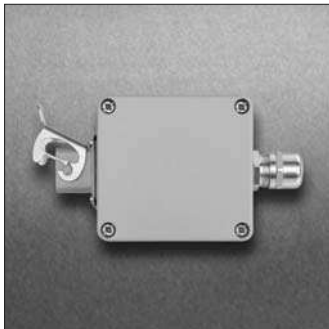

your part no.			
part no.	1401060110ME	1401060220ME	1401060320ME
colour			
type	1 Port straight	2 Port right	2 Port straight
EAN	4250184116424	4250184116431	4250184116448

- To accommodate E-DAT Industry RJ45 coupler/field jack

E-DAT Industry IP67 V1 2port metal outlet

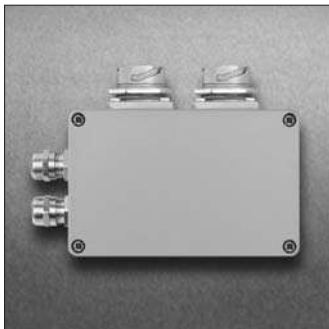

your part no.			
part no.	1401010110ME	1401010220ME	1401010620ME
colour			
type	1 Port straight	2 Port right	2 Port straight
EAN	4250184116455	4250184116462	4250184116479

- To accommodate E-DAT Industry RJ45 coupler/field jack insert and OpDAT Industry SC-RJ/2SC and LC-D adapter insert

E-DAT Industry IP67 V6 8(8) AP Cat.6



your part no.	
part no.	1309410003-E
colour	light grey
type	8(8)
EAN	4250184106517



E-DAT Industry IP67 V6 cable coupler

your part no.	
part no.	1309415003-E
colour	light grey
type	8(8)
EAN	4250184106579



Industry IP67 V4 plug housing



your part no.	
part no.	1401045002KE
colour	black
type	empty
EAN	4250184114024

- To accommodate E-DAT Industry RJ45 plug/field plug and OpDAT Industry 2SC and 2LC plug inserts

Industry IP67 V4 plug housing bend protected



your part no.	
part no.	1401055002KE
colour	black
type	empty
EAN	4250184114017

- To accommodate E-DAT Industry RJ45 plug/field plug and OpDAT Industry 2SC and 2LC plug inserts

Industry IP67 V5 metal plug housing



your part no.	
part no.	1401065000ME
colour	
type	empty
EAN	4250184116585

- To accommodate E-DAT Industry RJ45 plug/field plug

Industry IP67 V1 metal plug housing



your part no.	
part no.	1401015000ME
colour	
type	empty
EAN	4250184116592

- To accommodate E-DAT Industry RJ45 plug/field plug and OpDAT Industry 2SC and 2LC plug inserts

Industry IP67 V1 metal plug housing bend protected

your part no.	
part no.	1401025000ME
colour	
type	empty
EAN	4250184116608

- To accommodate E-DAT Industry RJ45 plug/field plug and OpDAT Industry 2SC and 2LC plug inserts



E-DAT Industry IP67 V4 bulkhead RJ45 coupler / field jack



your part no.		
part no.	1401243312KE	1401143312KE
colour	black	black
type	8(8) coupler	8(8) field jack
EAN	4250184114925	4250184114932

OpDAT Industry IP67 V4 bulkhead SC-RJ/2SC and LC-D



your part no.				
part no.	1402143322KE	1402K43322KE	1402343322KE	1402L43322KE
colour	black	black	black	black
type	SC-RJ/2SC (MM)	SC-RJ/2SC (SM)	LC-D (MM)	LC-D (SM)
EAN	4250184114949	4250184115915	4250184114956	4250184115939

E-DAT Industry IP67 V5 metal bulkhead RJ45 coupler / field jack



your part no.		
part no.	1401263310ME	1401163310ME
colour		
type	8(8) coupler	8(8) field jack
EAN	4250184114963	4250184114970

E-DAT Industry IP67 V1 metal bulkhead RJ45 coupler / field jack



your part no.		
part no.	1401213310ME	1401113310ME
colour		
type	8(8) coupler	8(8) field jack
EAN	4250184115007	4250184115014

OpDAT Industry IP67 V1 metal bulkhead SC-RJ/2SC and LC-D

your part no.				
part no.	1402113320ME	1402K13320ME	1402313320ME	1402L13320ME
colour				
type	SC-RJ/2SC (MM)	SC-RJ/2SC (SM)	LC-D (MM)	LC-D (SM)
EAN	4250184114987	4250184116011	4250184114994	4250184116028



OpDAT Industry IP67 2SC built-in flange

your part no.		
part no.	1501706203-E	1501706303-E
colour	light grey	light grey
type	2SC (MM)	2SC (SM)
EAN	4250184108092	4250184108108

- Easy-to-install round socket (25 mm)
- Flange 2SC with two electrical jacks for AWG 22-24 can be retrofitted



E-DAT Industry IP67 V4 RJ45 plug / field plug



	your part no.	
part no.	1401545012KE	1401445012KE
colour	black	black
type	8(8) plug	8(8) field plug
EAN	4250184114338	4250184114352

E-DAT Industry IP67 V4 RJ45 plug / field plug bend protected



	your part no.	
part no.	1401555012KE	1401455012KE
colour	black	black
type	8(8) plug	8(8) field plug
EAN	4250184114345	4250184114369

OpDAT Industry IP67 V4 2SC / 2LC plug



	your part no.				
part no.	1402545022KE	1402645022KE	1402745022KE	1402845022KE	1402945022KE
colour	black	black	black	black	black
type	2SC (MM)	2SC (SM)	2SC (POF)	2LC (MM)	2LC (SM)
EAN	4250184114376	4250184114390	4250184114437	4250184114451	4250184114475

OpDAT Industry IP67 V4 2SC / 2LC plug bend protected



	your part no.				
part no.	1402555022KE	1402655022KE	1402755022KE	1402855022KE	1402955022KE
colour	black	black	black	black	black
type	2SC (MM)	2SC (SM)	2SC (POF)	2LC (MM)	2LC (SM)
EAN	4250184114383	4250184114406	4250184114444	4250184114468	4250184114482

E-DAT Industry IP67 V5 RJ45 metal plug / field plug

your part no.		
part no.	1401565010ME	1401465010ME
colour		
type	8(8) plug	8(8) field plug
EAN	4250184114499	4250184114505



E-DAT Industry IP67 V1 RJ45 metal plug / field plug

your part no.		
part no.	1401515010ME	1401415010ME
colour		
type	8(8) plug	8(8) field plug
EAN	4250184114512	4250184114536



E-DAT Industry IP67 V1 RJ45 metal plug / field plug bend protected

your part no.		
part no.	1401525010ME	1401425010ME
colour		
type	8(8) plug	8(8) field plug
EAN	4250184114529	4250184114413



OpDAT Industry IP67 V1 2SC metal plug

your part no.			
part no.	1402515020ME	1402615020ME	1402715020ME
colour			
type	2SC (MM)	2SC (SM)	2SC (POF)
EAN	4250184114543	4250184114567	4250184114581



OpDAT Industry IP67 V1 2SC metal plug bend protected



	your part no.		
part no.	1402525020ME	1402625020ME	1402725020ME
colour			
type	2SC (MM)	2SC (SM)	2SC (POF)
EAN	4250184114550	4250184114574	4250184114598

OpDAT Industry IP67 V1 2LC metal plug



	your part no.	
part no.	1402815020ME	1402915020ME
colour		
type	2LC (MM)	2LC (SM)
EAN	4250184114604	4250184114628

OpDAT Industry IP67 V1 2LC metal plug bend protected



	your part no.	
part no.	1402825020ME	1402925020ME
colour		
type	2LC (MM)	2LC (SM)
EAN	4250184114611	4250184114635

E-DAT Industry IP67 V6 plug

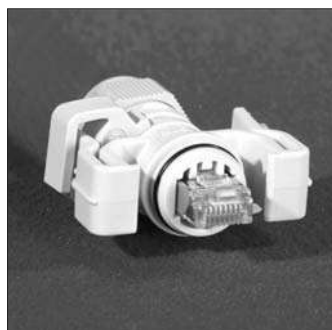

	your part no.
part no.	130906-03-E
colour	light grey
type	8(8)
EAN	4250184105381

- With locking clip
- Eight-pole RJ45 plug
- For coloured locking clips, see page 38

OpDAT Industry IP67 2SC plug



	your part no.	
part no.	1501716211-E	1501716311-E
colour	black	black
type	2SC (MM)	2SC (SM)
EAN	4250184110989	4250184110996

- Can be straightforwardly assembled in the field
- Plug 2SC with two electrical jacks for AWG 22-24 can be retrofitted



E-DAT Industry patch cable V6 IP67 - IP67

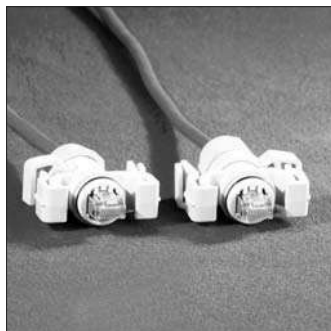

your part no.				
part no.	13094050106-E	130940A0106-E	130940A5106-E	130940B0106-E
colour	red	red	red	red
type	5.0 m	10.0 m	15.0 m	20.0 m
EAN	4250184111849	4250184111788	4250184111801	4250184111825

- Other lengths available to order

E-DAT Industry patch cable V6 IP67 - RJ45

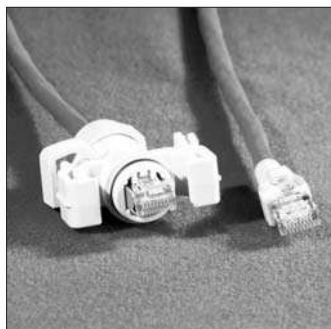

your part no.				
part no.	13094050206-E	130940A0206-E	130940A5206-E	130940B0206-E
colour	red	red	red	red
type	5.0 m	10.0 m	15.0 m	20.0 m
EAN	4250184111856	4250184111795	4250184111818	4250184111832

- Other lengths available to order

Industry IP67 V4 plug protective cap

your part no.	
part no.	1401048002KI
colour	black
type	plastic
EAN	4250184114161

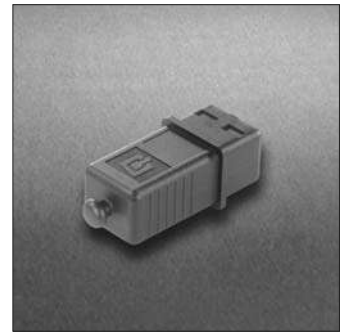

Industry IP67 V1 plug protective cap

your part no.	
part no.	1401018002KI
colour	black
type	plastic
EAN	4250184114192

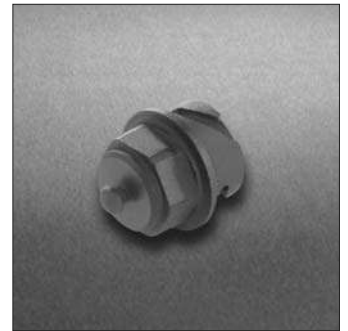

Industry IP67 V4 bulkhead protective cap

your part no.	
part no.	1401048102KI
colour	black
type	plastic
EAN	4250184114154

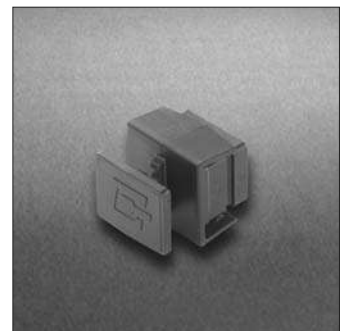

Industry IP67 V1 bulkhead protective cap

your part no.		
part no.	1401068100MI	1401018102KI
colour		black
type	metal	plastic
EAN	4250184114307	4250184114314

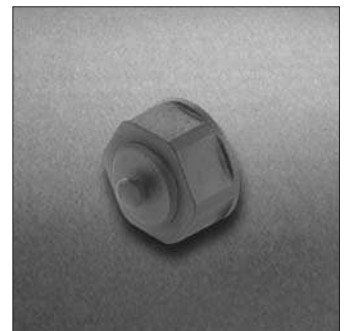

Industry colour coding ring V1/V4

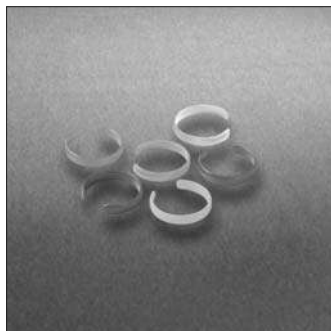

your part no.					
part no.	1401009004-I	1401009003-I	1401009001-I	1401009006-I	1401009005-I
colour	white	light grey	orange	blue	yellow
type	plastic	plastic	plastic	plastic	plastic
EAN	4250184115106	4250184115113	4250184115120	4250184115137	4250184115144

your part no.	
part no.	1401009007-I
colour	green
type	plastic
EAN	4250184115151

Plier wrench 1 3/8"



your part no.	
part no.	140301-E
colour	
type	
EAN	4250184115489

Locking clip for IP67 V6 plug

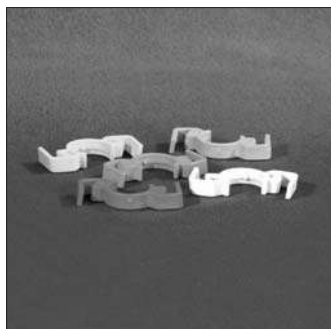

your part no.					
part no.	130906-V5-I	130906-V3-I	130906-V7-I	130906-V8-I	130906-V6-I
colour	yellow	light grey	green	red	blue
type	plastic	plastic	plastic	plastic	plastic
EAN	4250184105411	4250184105404	4250184105435	4250184105442	4250184105428

Mounting kit for mounting flanges IP67 V6 EbK and EbM

your part no.	
part no.	13094130-E
colour	
type	metal
EAN	4250184106524

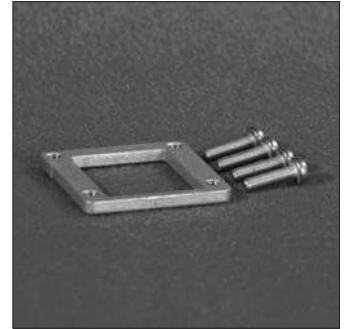

Dismantle tool for copper cable

your part no.	
part no.	140302-E
colour	black
type	
EAN	4250184115496



Assembly plier for E-DAT Industry IP20 RJ45 plug

your part no.	
part no.	130907-E
colour	black
type	8(8) plug
EAN	4250184105459

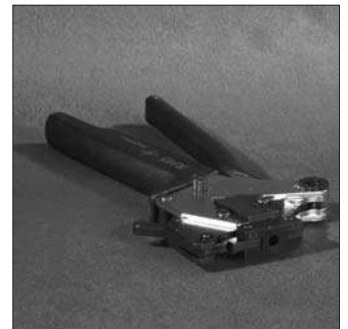

Cat.7 cable connector IP67

your part no.	
part no.	130863-01-E
colour	black
type	
EAN	4250184113195

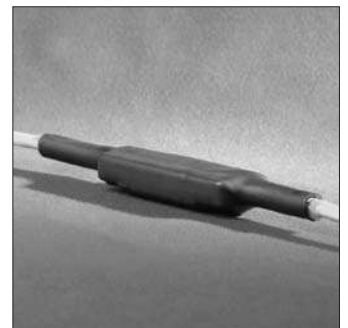

- IP67 protection through shrink-fit tube
- Cable feed from two ends
- Cable sharing possible

Screwdriver bulkhead V4

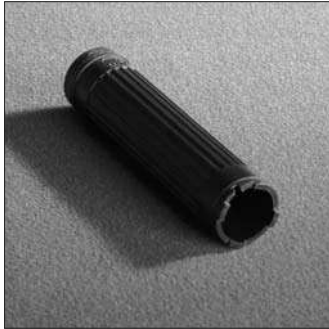

your part no.	
part no.	140310-E
colour	black
type	plastic
EAN	4250184115571



Description	Page
Your contacts	Page 42
Worldwide representations	Page 43
METZ CONNECT	Page 45



Your contacts



General management

Albert Metz

Managing Director and Owner

Jochen Metz

Managing Director and Owner

Torsten Janwlecke

Managing Director
+49 7702 533-181
TJanwlecke@metz-connect.com

Hans-Peter Bieler

Sales Manager
+49 7702 533-190
HBieler@metz-connect.com

Simone Kilian

Secretary
+49 7702 533-181
SKilian@metz-connect.com

Product Management

Roland Dold

Senior Product Manager
+49 7702 533-187
RDold@metz-connect.com

Günther Wohlhüter

Product Manager
+49 7702 533-194
GWohlhueter@metz-connect.com

Tobias Münzer

Product Marketing Manager
+49 7702 533-193
TMuenzer@metz-connect.com

Key Account Management

Klaus Schulze

Key Account Manager
+49 7702 533-182
KSchulze@metz-connect.com

Carsten Dietz

Key Account Manager
+49 7702 533-195
CDietz@metz-connect.com

Export

Gerald Fröhlich

International Sales Manager
+49 7702 533-198
GFroehlich@metz-connect.com

Axel Homburger

Area Sales Manager
+49 7702 533-150
AHomburger@metz-connect.com

Sales Team

Christine Großer

+49 7702 533-185
CGrosser@metz-connect.com

Sandra Kipnik

+49 7702 533-172
SKipnik@metz-connect.com

Miriam Kuntz

+49 7702 533-183
MKuntz@metz-connect.com

Reiny Müller

Export Back Office
+49 7702 533-184
RMueller@metz-connect.com

Encarnita Olid

+49 7702 533-171
EOLID@metz-connect.com

Representations

Egypt

Egy Trade

6, Misr el Tamir Buildings
Masken Sheraton Second Area
11771 Heliopolis, Cairo
Phone +202 2660538
Fax +202 6379397
egy-trade@pop.thewayout.net

Israel

C-Vision

Computer Systems Ltd.
9 Haomanut Street
Poleg Industry Area
Natanya
P.O.B.:8416 ZIP: 42504
Phone +972 (9)8633066
Fax +972 (9)8633065
info@c-vision.co.il
www.c-vision.co.il

Luxembourg

SOGEL

1, Dernier Sol
B.P. 1941
L - 1019 Luxembourg
Phone +352 400505 1
Fax +352 400505 305
sogel@sogel.lu
www.sogel.lu

TLT Teletonico S.a.r.l.

89, route d'Esch
L - 4985 Sanem
Phone +352 590044
Fax +352 590081
info@tlt.lu
www.tlt.lu

Netherlands

Voltec

Nieuw Eckholt 282
NL - 6419 DL Heerlen
Phone +31 45 5718090
Fax +31 45 5714132
info@voltec.nl
www.voltec.nl

Austria

VOLTOHM

Frutzstr. 4
A - 6832 Sulz
Phone +43 5522 49420
Fax +43 5522 42141
info@voltohm.at
www.voltohm.at

Poland

CETO

Golêcińska 9
PL - 60-626 Poznań
Phone +48 61 84790-57 and -54
Fax +48 61 8411549
kwesolowski@ceto.com.pl
www.ceto.com.pl

Rumania

RO-TELECONNECT S.R.L.

Str. Noua Nr. 72
RO - 505 100 Codlea
Phone +40 268 506333
Fax +40 268 253090
office@teleconnect.ro
www.teleconnect.ro

EBS - Engender Business Systems SRL

Str. Radu Popescu 5, sect. 1
Bucuresti
Phone +40 21 2224243
Fax +40 21 2224245
office@ebs.com.ro
www.ebs.com.ro

Russia

Numerix

Pawilion 5, Office 45
RU - 107113 Moscow
Phone +7 095 2686428
Fax +7 095 9138228
info@numerix.ru
www.numerix.ru

Sweden

Eriksson Business Development

Kvarnvägen 28
SE - 511 63 Skene
Phone +46 706 939314
Fax +46 706 196009
per-anders@p-eriksson.se
www.p-eriksson.se

Switzerland

BTR swiss AG

Phone +41 71 9201030
Fax +41 71 9201031
RMueller@metz-connect.com
www.btr-netcom.com

Slovenia

Pronet d.o.o.

Medvedova 13
SI - 2000 Maribor
Phone +386 2 2296600
Fax +386 2 2521770
info@pronet.si
www.pronet.si

Spain

Temper S.A.U.

Poligono Industrial, Nave 18
E - 33199 Granda-Siero
Asturias
Phone +34 902 210292
Fax +34 902 201303
info@temper.es
www.temper.es

Czech Republic

Designa s.r.o

Solovská 87
CZ - 180 00 Praha 8
Phone +420 220800179
Fax +420 283871411
sales@designa.cz
www.designa.cz

Ukraina

BTR - Office 309

Sapadynskaja Str. 5
UA - 04123 Kiev
Phone +38 044 4301285
Fax +38 044 4301285
kiev-btrsystems@ukr.net

USA

RIA CONNECT Inc.

200 Tornillo Way
Tinton Falls
NJ 07712
Phone +1 732 389-1300
Fax +1 732 389-9066
info@riaconnect.com
www.riaconnect.com

METZ CONNECT worldwide

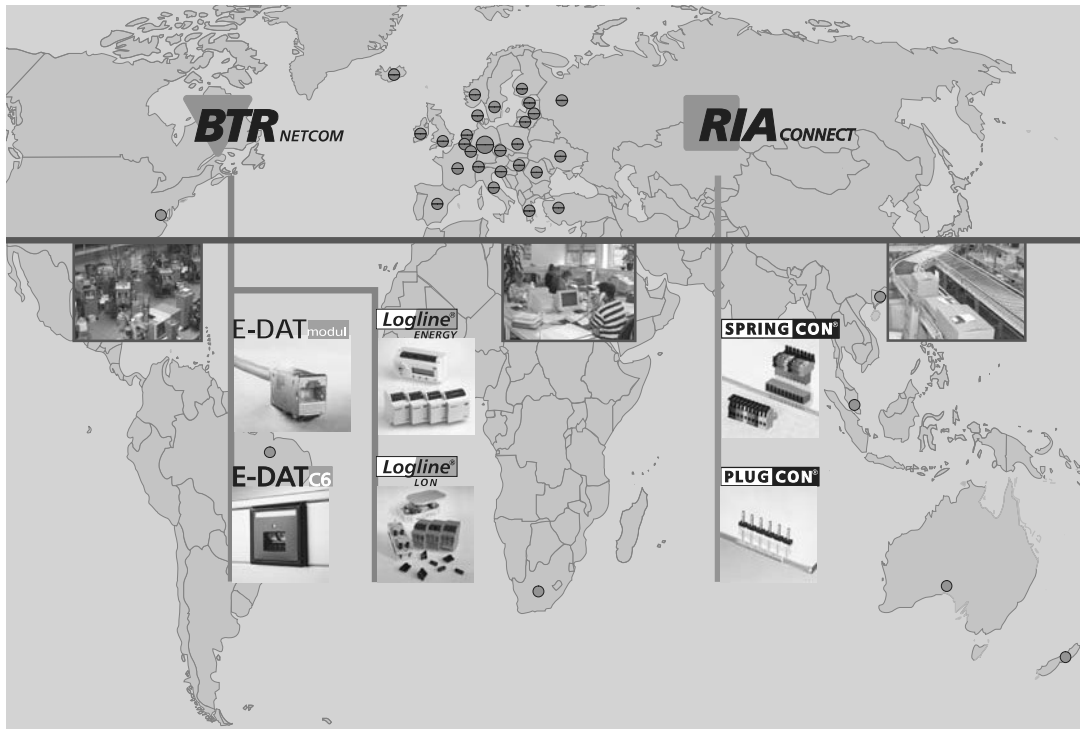

METZ CONNECT Headquarters



Facility #1, Blumberg

General Management, administration, marketing, materials logistics, RIA production



Facility #2, Blumberg

BTR production, plastic injection moulding shop, quality management, tool making



Facility #3, Blumberg

RIA and BTR Sales Departments, RIA and BTR Logistics Centre, Innovation Centre for research and development, RIA and BTR production.

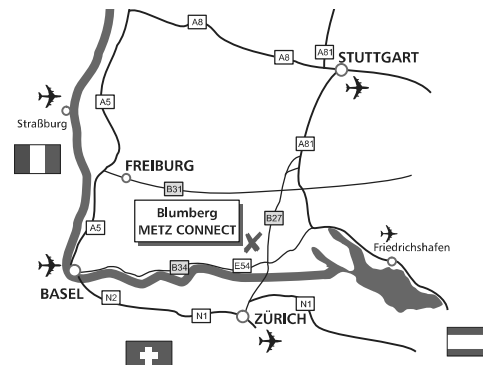

BTR NETCOM GmbH is a METZ CONNECT Company



BTR NETCOM GmbH
IT CONNECT Division
Im Tal 2
78176 Blumberg
Germany
Phone +49 7702 533-0
Fax +49 7702 533-433
www.btr-netcom.com

BTR NETCOM GmbH
ELECTRONIC SYSTEMS Division
Im Tal 2
78176 Blumberg
Germany
Phone +49 7702 533-0
Fax +49 7702 533-433
www.btr-netcom.com

BTR swiss AG
Flawilerstraße 31
9500 Wil
Switzerland
Phone +41 719201030
Fax +41 719201031
www.btr-netcom.com



RIA CONNECT GmbH
Im Tal 2
78176 Blumberg
Germany
Phone +49 7702 533-0
Fax +49 7702 533-122
www.ria-connect.com

RIA CONNECT, Inc.
200 Tornillo Way
Tinton Falls, NJ 07712
USA
Phone +1-732-389-1300
Fax +1-732-389-9066
www.riacconnect.com

RIA électronique SAS
16, rue de Reims, B.P. 232
67006 STRASBOURG CEDEX
France
Tél. +33 388617073
Fax +33 388619473
www.ria-connect.com



MC TECHNOLOGY GmbH
Ottilienweg 9
78176 Blumberg
Germany
Phone +49 7702 533-0
Fax +49 7702 533-433
www.mc-technology.net



METZ CONNECT Hungary Kft
1201 Budapest
Helsinki út 51
Hungary
Phone +36 1 283 0037
Fax +36 1 284 0947



METZ CONNECT Asia Pacific Ltd.
1501B World-Wide House
19 Des Voeux Road Central
Hong Kong