

### Features & Benefits

- Long Life, High-Rate CR-AG Cylindrical Cell
- Lithium Metal Chemistry for High-Capacity
- Spiral Design for High-Rate/Pulse Discharge
- Solder Leads for Easy Connection and Replacement
- PTC for Increased Safety

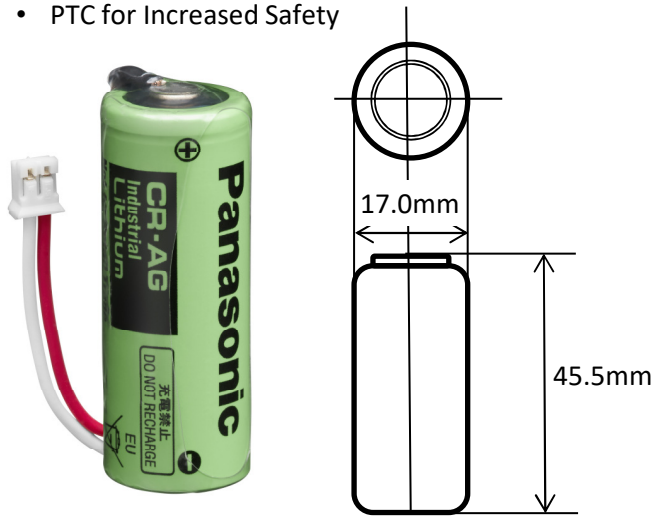

See specific dimensions attached.

### Applications

Suitable for infrastructure devices requiring reliable, long-life power; Smoke and Carbon Monoxide Detectors, Gas and Water Meters, Security Devices, iBeacons, IoT/Sensing Devices, etc...

Part number		CR-AGC22N
Nominal Voltage		3V
Nominal Capacity		2400 mAh
Continuous drain		2.5mA
Dimensions* <sup>1</sup>	Diameter(Max.)	17.0mm
	Height(Max.)	45.5mm
Weight* <sup>1</sup>		Approx. 22.0g
Operating Temperature		-40°C ~ +85°C* <sup>2</sup>

\*1 Without leads

\*2 Please consult Panasonic when anticipating usage with operating temperatures exceeding 70°C.

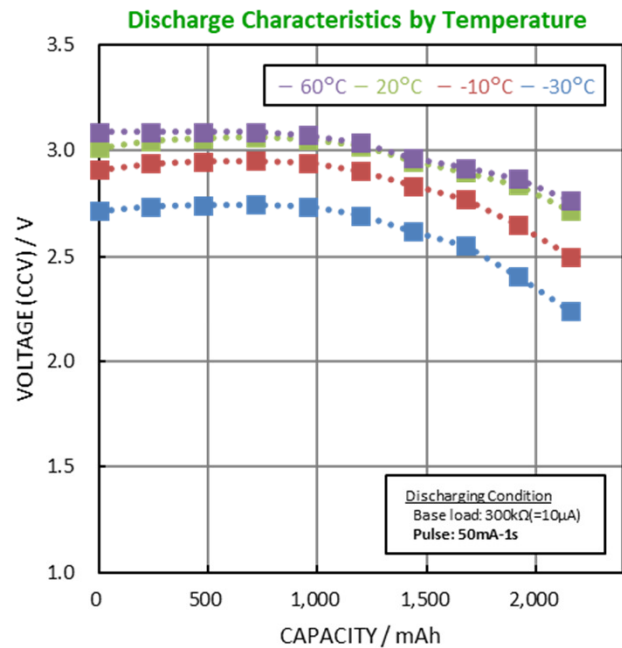
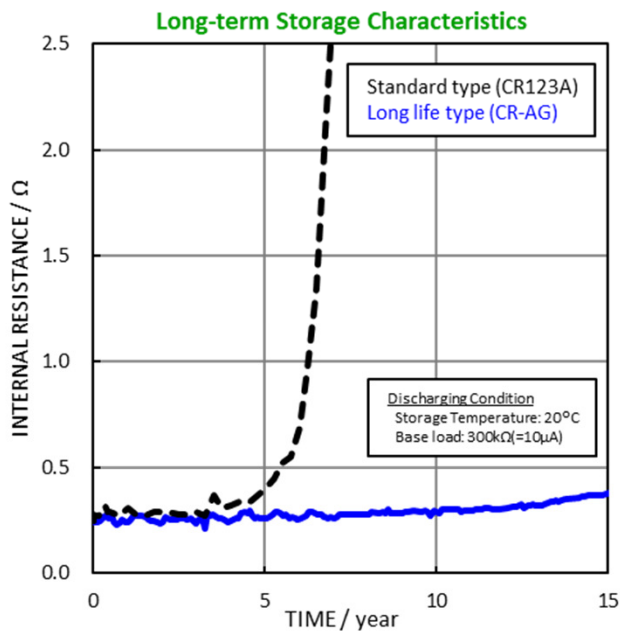

The data in this document is for descriptive purposes only and is not intended to make or imply any guarantee or warranty. The contents of this datasheet are subject to change without notice. October 2020

Panasonic Corporation

[oembatteries@us.panasonic.com](mailto:oembatteries@us.panasonic.com) (877) 226-7224

<https://industrial.panasonic.com/ww/products/batteries/primary-batteries/lithium-batteries/lineup>

SYMBOL	DATE	REVISION	SIGNED	CHECKED
△	May. 17, 2022	CHANGE OF DIMENSION (18.3±1.5→19.5±1.5) CHANGE OF PRODUCT NO. & DRAWING NO.	KW	TY

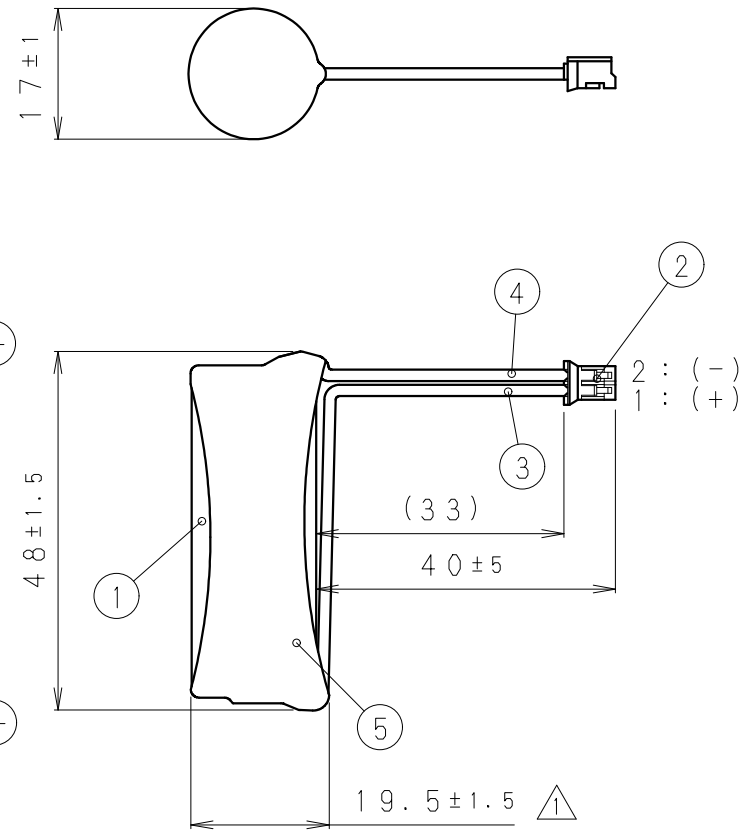

CIRCUIT DIAGRAM

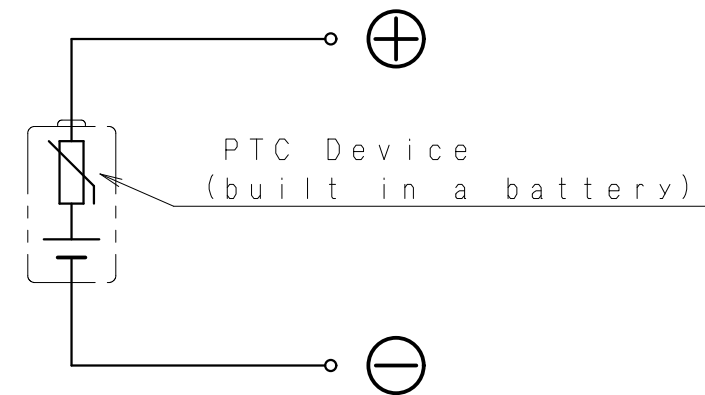

NOTE  
 1. NOMINAL VOLTAGE: 3 V  
 2. ( ) : REFERENCE DIMENSION AND ANGLE

No	CONTENTS	
①	BATTERY	CR-AGD : PANASONIC YELLOW-GREEN
②	CONNECTOR	JST
	HOUSING	PHR-2
	TERMINAL	SPH-002T-P0.5S : TIN PLATING
③	(+) LEAD WIRE	UL AWM3385 AWG24 : RED
④	(-) LEAD WIRE	UL AWM3385 AWG24 : WHITE
⑤	OUTER TUBE	HEAT SHRINKABLE TUBE : TRANSPARENT

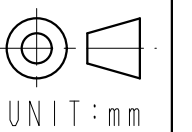

UNLESS OTHERWISE SPECIFIED DIMENSIONS ARE IN TOLERANCES ON 'STANDARD TOLERANCE'	NOMINAL SIZE		STANDARD TOLERANCE		PRODUCT NO.	NAME	
	≤6	6<~≤30	±0.5	±2.0			△ CR-AGC22
30<~≤120	120<~≤400	±3.0	±5.0	PRODUCT DRAWING			
NOMINAL ANGLE		±5°					
SCALE	DESIGNED	DRAWN	CHECKED	CHECKED	APPROVED	DRAWING NO.	REV.
1:1	SN Aug. 24, 2016	SN Aug. 24, 2016	TK	TM	TY	△ PD-CR-AGC22-G	1

## Precautions for use

- 1) The battery shall not be stored at temperatures in excess of 45°C. Storage at less than 35°C is recommended. Storage at less than -20°C can deform the plastic parts and may cause leakage. To prevent self-discharge caused by corrosion or decrease of insulation, humidity during storage shall be less than 70%RH.

Do not expose batteries to direct sunlight or moisture in order to prevent deterioration of performance.

- 2) The battery has an explosion resistant construction. But the following cautions should be taken, because combustible materials such as Lithium metal and organic electrolyte are contained in the battery.

- \* Do not use except in applicable model or equipment.
- \* Do not connect other cell in series.
- \* Do not mix new (fresh) and old (end of life) batteries.
- \* Do not force-discharge.
- \* Do not mix different types (chemistries) of batteries.
- \* Do not short circuit.
- \* Do not dispose in fire.
- \* Do not charge.
- \* Do not disassemble.
- \* Do not heat up more than 100°C.
- \* Do not solder directly onto batteries.
- \* Do not soak in water.
- \* Do not deform.
- \* Do not inadequately modify and remodel for installation.
- \* Insert the batteries in correct polarity position.

- 3) Keep away from heat source or flame.
- 4) Do not wash by ultrasonic wave washer.
- 5) Keep away from children and infants to prevent the possibility of swallowing by mistake.

## Battery Safety Practices

### Avoiding hazards in lithium battery handling

 **Warning** Mishandling batteries can cause battery leakage, heat generation, rupture, ignition etc., that can lead to possible fire or injury.

Both of coin type and cylinder type of lithium batteries contain flammable materials such as lithium, organic solvent and other chemical ingredients. Improper handling of lithium batteries may result in heat generation, fire or explosion, with a risk of personal injury or damage. To prevent these accidents in battery handling, be sure to observe the following precautions.

**1) Do not Short circuit**

Direct connection of plus (+) and minus (-) poles may result in leakage, heat generation, explosion and/or fire. Do not store and/or carry batteries with metallic product such as necklace. (Refer fig.1)

**2) Do not stack and/or jumble batteries**

Stacked and/or jumbled batteries may cause short circuit and/or forced discharge by the contact of other batteries. This may result in leakage, heat generation, explosion and/or fire. Especially, a connection with the 006P(9V) type batteries may have a high risk of leakage, heat generation, explosion and/or fire. (Refer fig.2 & 3)

**3) Do not make forced discharge batteries**

Forced discharge by external power source, the battery voltage goes to negative and this cause gas generation in inside of the battery. This may result in leakage, heat generation, explosion and/or fire. (Refer fig.3)

\*In your disposal and/or storage of the batteries, please isolate plus and minus poles by adhesive tape. A connection with other metals and/or batteries may result in leakage, heat generation, explosion and/or fire.

\*When using the stored battery, please remove the tape perfectly to avoid high contact resistance problem. (Refer fig.4)

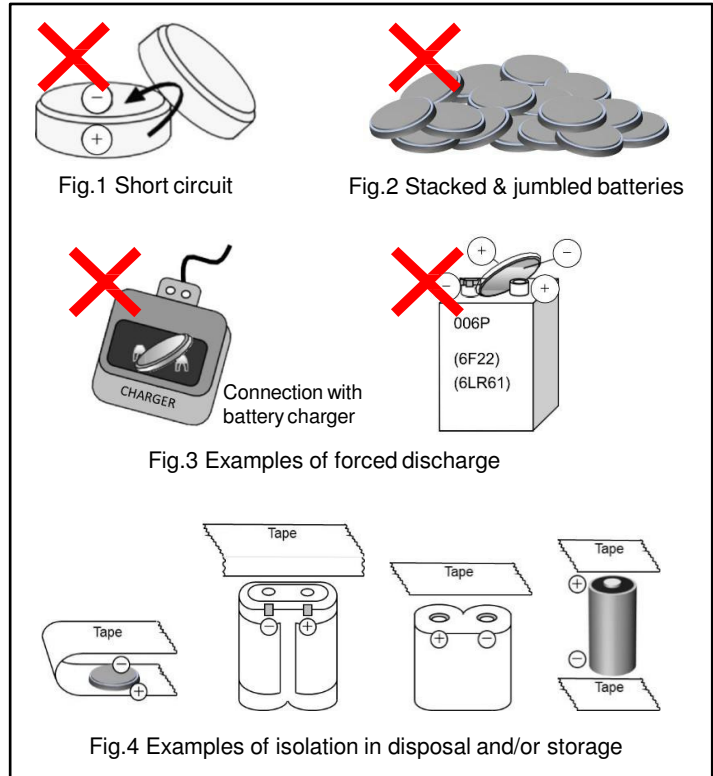

**4) Do not dispose of batteries in fire**

Disposal of batteries in fire is extremely dangerous with a risk of explosion and violent flaring.

**5) Do not heat batteries**

Heating batteries above 100°C (212°F) may damage the resin in crimping, separator and other parts, causing electrolyte leak, internal short circuit, fire and explosion.

**6) Do not solder directly onto batteries**

Direct soldering onto batteries may damage the resin in crimping, separator and other parts, causing electrolyte leak, internal short circuit, fire and explosion.

**7) Do not charge batteries**

Charging of primary batteries may result internal gas generation, causing electrolyte leak, battery swelling, fire and explosion.

**8) Do not disassemble batteries**

Disassembly batteries may cause gas generation that may irritate your throat. Lithium may also react with moisture to generate heat and fire.

**9) Do not deform batteries**

Applying extreme pressure to batteries may cause deformation of the crimping and internal short circuit, causing electrolyte leak, battery swelling, fire and explosion.

**10) Do not mix different type batteries**

For some applications, mixing of different type batteries, or new and old batteries, can cause over discharge due to differences in voltage and discharge capacities. This may lead to the risk of swelling and/or explosion.

**11) Do not insert batteries with opposite polarity**

For some applications, battery insertion with opposite polarity (reverse insertion of plus and minus) may result in leakage, heat generation, explosion and/or fire.

Please ensure the above precautions are strictly observed by related divisions including production departments, sales departments and external subcontractors. For additional details and information, please contact our sales representatives.

**Disclaimer**

- 1) You shall not alter, change, repair, improve or modify our battery ("Battery"). Panasonic Corporation ("Panasonic") shall not be responsible for any issues caused by modifications to the Battery taken place after that the Battery is delivered to the customer.
- 2) Panasonic shall not warrant or be responsible in any case where you fail to carry out proper handling, operating, installation, testing, service and checkout of the Battery and/or to follow the instruction, cautions, warnings, and notes provided in this data sheet.
- 3) In no event shall Panasonic be responsible for any defects of the Battery or any performance of any devices in which the Battery are incorporated.
- 4) Panasonic makes no representation or warranties, express or implied, with respect to the Battery, including, but not limited to, the implied warranties of merchantability and of fitness for a particular purpose.
- 5) Panasonic shall not take any responsibility for the use or incorporation of the Battery for or into devices for which failure or malfunction of the Battery may directly jeopardize life or cause threat of personal injury, such as for medical equipment, vehicle equipment, aircraft and aerospace equipment, aircraft electronics equipment, explosion-proof equipment or any other similar equipment.
- 6) IN NO EVENT SHALL PANASONIC, REGARDLESS OF THE LEGAL REASON, TORT OR OTHERWISE, BE LIABLE TO YOU AND/OR ANY THIRD PARTIES FOR ANY LOST PROFITS OR FOR SPECIAL, DIRECT, INDIRECT, INCIDENTAL OR CONSEQUENTIAL DAMAGES, INCLUDING, WITHOUT LIMITATION, ANY LOSS, DAMAGES, COSTS AND EXPENSES ARISING FROM OR IN CONNECTION WITH THE USE OF THE BATTERY AND/OR ANY LOSS OF ELECTRICAL POWER, COMMUNICATION AND DATA.
- 7) You shall, to the extent available under applicable law, defend, indemnify and hold Panasonic, its affiliates, customers, and its and their respective officers, directors, agents, servants, representatives and employees (collectively, "Panasonic Parties") harmless from and against all losses, liabilities, damages, claims, demands, actions, proceedings, lawsuits, judgments, governmental orders, recalls, proposed recalls and all costs and expenses, including but not limited to reasonable attorneys' fees and other professionals' fees and expenses incurred in the investigation or defense thereof or the enforcement of rights hereunder, in each case whether or not resulting from third party claims (collectively, "Claims"), arising out of or in connection with the Battery. For the avoidance of doubt, you shall defend, indemnify and hold the Panasonic Parties harmless from and against any and all Claims arising out of or in connection with (i) death or injury to any person, or damage to any property, resulting, directly or indirectly, from the design, manufacture, assembly, purchase, sale, use, operation or disposal of the Battery, (ii) any loss of an electrical power, communication or data due to the Battery regardless of the cause thereof, or (iii) your failure to comply with the terms and conditions set forth in this disclaimer.
- 8) This disclaimer may be subject to change without notice.